

MYFLEXY

Spazi in crescita

Growing spaces

MYFLEXY

Spazi in crescita

Growing spaces



Per noi crescere significa esplorare e sognare, imparare a misurarsi con nuovi obiettivi e raggiungere grandi traguardi, maturare per diventare ciò che poi saremo da adulti. Per questo è nato Myflexy, un programma d'arredo flessibile e versatile che segue le diverse fasi della crescita del bambino. Dedicate al mondo kids, teen e young, le tre linee prodotte sono disegnate nel segno di una maggiore fruibilità e trasversalità dei vari elementi (armadi, letti, scrivanie, librerie e accessori) nel tempo. Un racconto costruito con forme ergonomiche, semplici e funzionali che lasciano libero spazio all'interpretazione e alla fantasia.

We understand that growing up is the chance to explore and dream, learning how to face new challenges and reach ambitious goals, becoming what we will be as adults. Those are the reasons why we created Myflexy, an adaptable furnishing system that fits the different stages of a child growth. Myflexy includes three product lines dedicated to the world of kids, teens and young people, and they are conceived under the sign of bigger usability and the wide variety of its elements (wardrobes, beds, desks, bookcases and accessories) to last. It is a story created with ergonomic, functional and simple shapes, which let interpretation and creativity run free.

Indice

—

Index

P 4-7

**Perché
scegliere FAER**

Why choose FAER

P 8-49

**Ambienti
KIDS**

KIDS compositions

P 50-103

**Ambienti
TEEN**

TEEN compositions

P 104-145

**Ambienti
YOUNG**

YOUNG compositions

P 146-151

Focus armadi

Wardrobes focus

P 152-159

Finiture

Finishes

**TANTE BUONE
RAGIONI PER
SCEGLIERE FAER**

**SO MANY
GOOD REASONS
TO CHOOSE FAER**

#1 Salute

Health

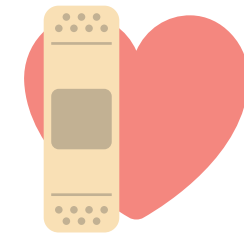

Per tutelare la salute dei bambini e dei ragazzi e nel rispetto dell'ambiente, abbiamo scelto di utilizzare pannelli ecologici con basse emissioni di formaldeide, certificati F**** nella scala dei Japanese Industrial Standards, e impiegare solo vernici all'acqua prive di qualsiasi elemento tossico.

To protect the health of children and teens, respecting the environment, we decided to use environmentally friendly panels with low formaldehyde emissions, conforming to the JIS F**** standard, and use only water-based coatings free of any toxic element.

#2 Sicurezza

Safety



Per noi sicurezza significa cultura di prodotto, per questo studiamo con cura e nel dettaglio i diversi elementi delle composizioni, che vengono realizzati e testati secondo i più rigidi standard europei.

We understand that safety of products is a must, that is why we study carefully and in detail the different elements of the compositions, which are made and tested respecting the most strict European standard.

#3 Flessibilità

Flexibility

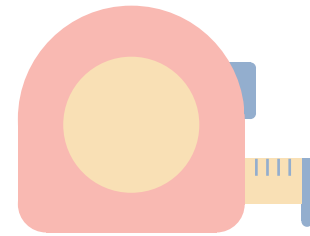

Abbiamo disegnato arredi dalle infinite possibilità di combinazione, all'insegna della massima flessibilità compositiva. Le lavorazioni su misura e l'impiego del sistema a spalla garantiscono la personalizzazione di tutti gli elementi.

We have designed furnishing complements with countless module combinations, according to the greatest flexibility in assembling. The adjustable bridges, the custom-made works and the use of the side system ensures the customization of all the modules.

#4 Solidità

Solidity

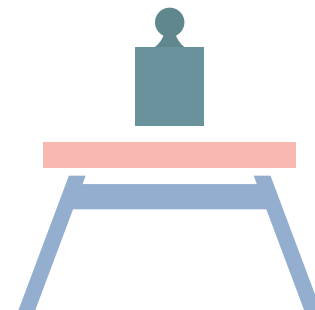

Sappiamo che i bambini hanno bisogno di un ambiente sicuro dove crescere, per questo progettiamo prodotti resistenti che durano a lungo. Lo spessore strutturale, il fondo in multistrato dei letti rialzati e la ferramenta premontata Blum garantiscono la solidità e l'affidabilità di tutti gli elementi.

We know that children need a safe environment where to grow, that is why we design long-lasting products. The structure thickness, in addition to the solid wood basement of suspended beds and the Blum pre-assembled hardware ensures solidity and reliability to all modules.

#5 Tecnologia

Technology

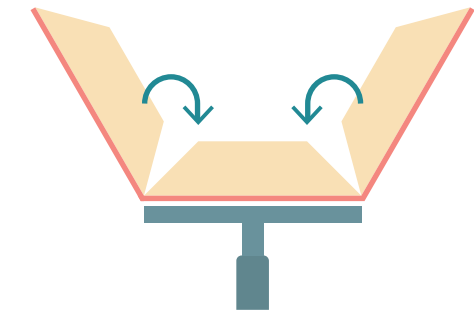

Per creare prodotti tecnicamente innovativi e curati in ogni dettaglio abbiamo adottato tecnologie all'avanguardia di “robotizzazione del legno” nella nostra linea produttiva. Ci avvaliamo inoltre della lavorazione folding per realizzare contenitori senza giunture e impieghiamo componenti e ferramenta nel segno della massima efficienza.

To create technically innovative and smart products we adopted advanced robotic technologies for the wood manufacture. In addition, we also make use of the “folding” manufacturing to produce cupboards without joints, and we use technical components and hardware according to the greatest efficiency.

#6 Qualità

Quality



Produciamo elementi curati nei dettagli e creativi nel design –simbolo del made in Italy nel mondo– e ricerchiamo da sempre la qualità che dura nel tempo, intesa come prodotto e come servizio al cliente. La certificazione ISO 9001/2008 garantisce il controllo di tutto il processo produttivo nel rispetto degli standard europei.

We produce smart and well designed elements, representing a real Made in Italy design icons all over the world, and we always look for the long-lasting quality in terms of products and customer care. The iso 9001/2008 certification ensures control of the entire manufacturing process, according to the European standards.

KIDS

Camere accoglienti ed ordinate, progettate a misura di bambino. Luoghi dove sognare, giocare, studiare e al contempo capaci di contenere e organizzare. Gli elementi delle composizioni, dal design pulito, giocoso e flessibile, sono stati pensati per rispondere alle diverse esigenze di crescita fino ai primi anni dell'adolescenza.

The bedrooms included in the kids line are comfortable and perfectly fitted for children. They are perfect places where to dream, play and study, but also good for the storage and to organize their own space. Each element has a fresh, joyful and flexible design, and has been designed to satisfy the different needs of growth, reaching the earlier adolescence years.

**Un ambiente sicuro
e sorprendente dove
crescere e giocare.**

*A surprisingly safe environment
where you can play and grow.*



IN QUESTE PAGINE

Armadio ad anta battente con maniglia Flat medium, articolazione ponte composta da elemento basso a due ante e ponte con maniglia Ghost. Turca con cassettoni e letto rialzato con protezioni imbottite Base. Contenitori pensili in folding. Tavolino Wood.

IN THESE PAGES

Wardrobe with Flat medium handle and bridging system composed by low cabinet and bridge cabinet with Ghost built-in handle. Couch with drawers, suspended bed with upholstered Base protections, "folding" manufactured wall units. Wood bedside table.



**Una camera dove
l'immaginazione
prende il volo.**

A bedroom where imagination can fly.



P. 14



P. 32



P. 20

Indice
composizioni
—
Composition
index



P. 26



P. 44



P. 38

ROOM #1

FINITURE
FINISHES



BIANCO



TURCHESE



PETROLIO



TESSUTO BIANCO

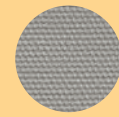

TESSUTO GRIGIO NEUTRO

ARREDI
FURNITURE

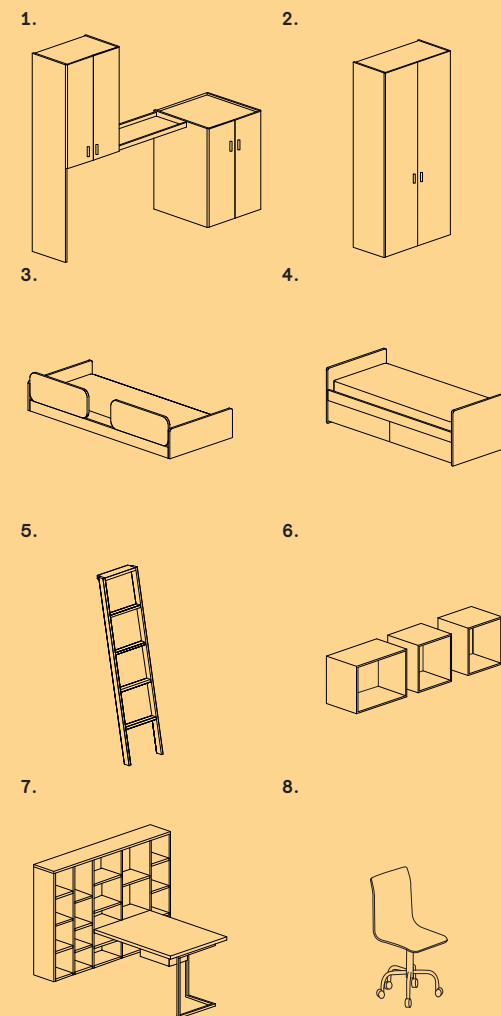
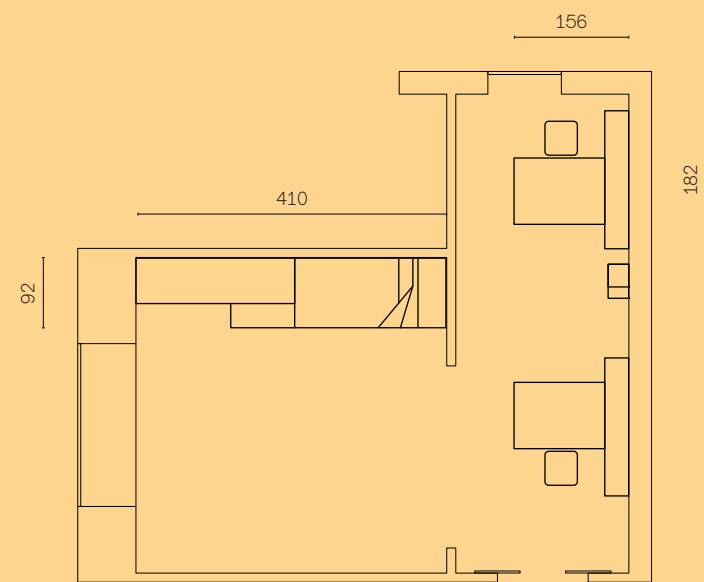

- | | |
|---------------------------|-----------------------|
| 1. ARTICOLAZIONE PONTE | 1. BRIDGING UNIT |
| 2. ARMADIO | 2. WARDROBE |
| 3. LETTO RIALZATO | 3. SUSPENDED BED |
| 4. TURCA | 4. PLATFORM BED |
| 5. SCALETTA | 5. STEPLADDER |
| 6. CONTENITORI PENSILI | 6. WALL UNITS |
| 7. LIBRERIA CON SCRIVANIA | 7. BOOKCASE WITH DESK |
| 8. SEDIA | 8. CHAIR |



ZONA NOTTE

Composizione di armadio alto e articolazione ponte composta da: elemento basso a due ante (profondità 94,5 cm) con maniglie Flat medium e ponte con maniglia incassata Ghost. Turca con cassettoni e letto rialzato con protezioni imbottite.

SLEEPING AREA

Wardrobe and bridging system composed by: low cabinet (depth 94.5 cm) with Flat medium handle, bridge cabinet with Ghost built-in handle. Couch with drawers and suspended bed with upholstered protections.

Myflexy

Le librerie sono modulari e personalizzabili con contenitori, cassetti e ante.

The bookcases are customizable with drawers, cases and doors.

Room #1



ZONA STUDIO

Libreria modulare sospesa con scrivania a basamento Corner in metallo, sedia Basic girevole con seduta imbottita e contenitori pensili in folding.

WORKSPACE

Wall-mounted modular bookcase with integrated desk, metal Corner base, turnable upholstered Basic chair and "folding" manufactured open wall units.

ROOM #2

FINITURE
FINISHES



FOG



CIPRIA



VERDE OASI



TESSUTO
ROSA

ARREDI
FURNITURE

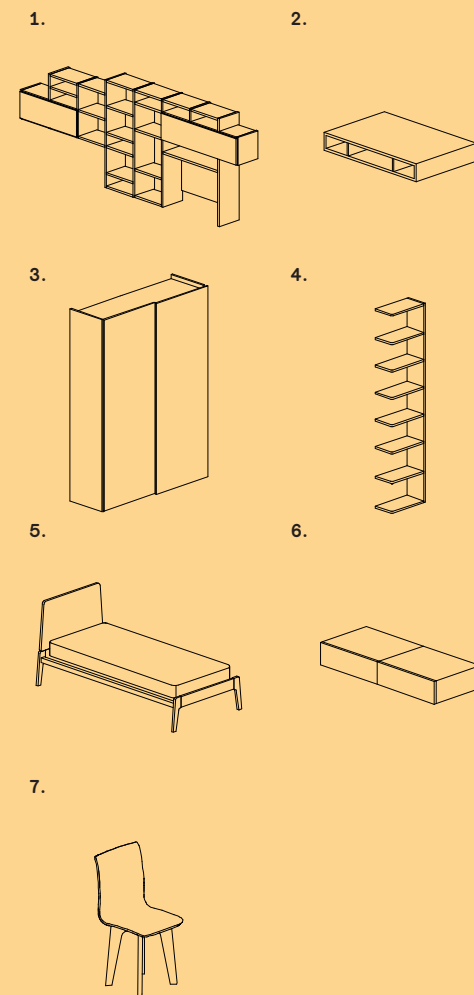
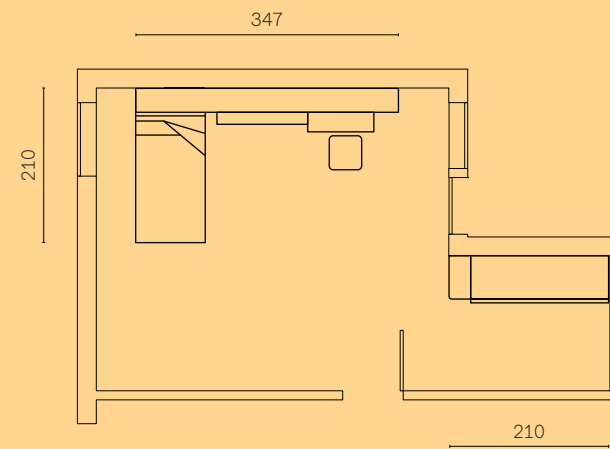

- | | |
|-------------------------------|--------------------------|
| 1. LIBRERIA | 1. BOOKCASE |
| 2. SCRIVANIA | 2. DESK |
| 3. ARMADIO AD ANTE SCORREVOLI | 3. SLIDING DOOR WARDROBE |
| 4. TERMINALE A GIORNO | 4. OPEN END UNIT |
| 5. LETTO | 5. BED |
| 6. COMODINI | 6. BEDSIDE TABLE |
| 7. SEDIA | 7. CHAIR |



ZONA NOTTE/STUDIO

Letto Wood, comodini, libreria modulare sospesa con gioco di antine (apertura push-pull) e scrivania integrata in folding. Sedia Wood con seduta imbottita.

SLEEPING AREA AND WORKSPACE

Wood bed, wall-mounted bedside table, wall-mounted modular bookcase with integrated "folding" manufactured desk and push-pull doors. Wood upholstered chair.





ARMADIATURA

Armadio ad ante scorrevoli con terminale a giorno.

WARDROBE

Sliding-door wardrobe with open end unit.

ROOM #3

FINITURE
FINISHES



BIANCO



AMBROSIA



PETROLIO

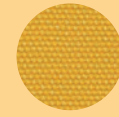

TESSUTO GIALLO

ARREDI
FURNITURE

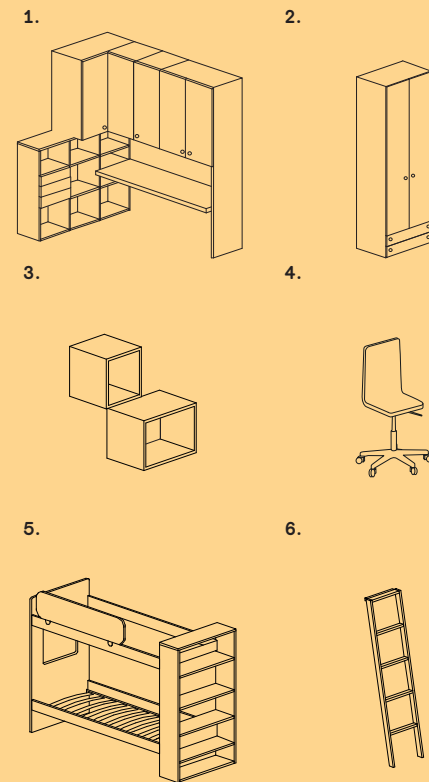
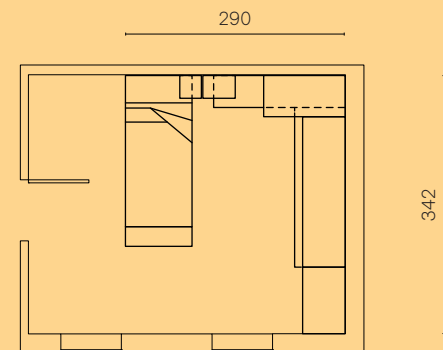

1. ARTICOLAZIONE PONTE AD ANGOLO CON LIBRERIA SOTTOPONTE E SCRIVANIA
2. ARMADIO
3. CONTENITORI PENSILI
4. SEDIA
5. LETTO A CASTELLO COMBO
6. SCALETTA

1. BRIDGING UNIT WITH BOOKCASE AND DESK
2. WARDROBE
3. WALL UNITS
4. CHAIR
5. COMBO BUNK BED
6. STEPLADDER



ZONA NOTTE

Letto a castello Combo con libreria integrata.
Protezioni Base.

SLEEPING AREA

Combo bunk bed with integrated bookcase.
Base protections



**ZONA STUDIO E ARMADIATURA**

Contenitori pensili in folding, libreria modulare sottoponte con cassetti, scrivania King in folding (spessore 6 cm). Articolazione ponte ad angolo, armadio a due ante e cassetti con maniglia Fix e sedie Raz con sedute imbottite.

WORKSPACE WITH WARDROBE

“Folding” manufactured open wall units, modular bookcase with drawers, King desk (thickness 6 cm), bridging unit, hinged door wardrobe with drawers, Fix handle, Raz upholstered chairs.

ROOM #4

FINITURE
FINISHES



SAMARA BIANCO



ROVERE MANDORLA



CIPRIA



PETROLIO

ARREDI
FURNITURE

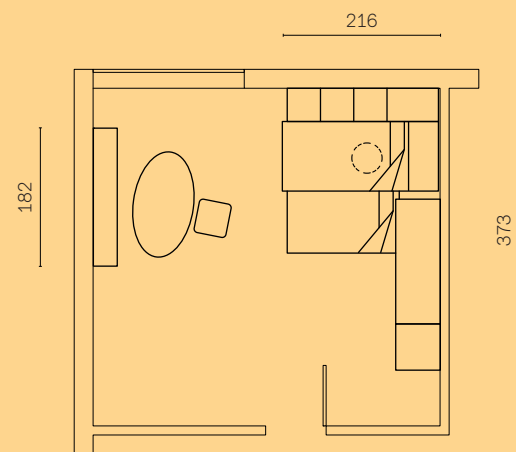

- | | |
|--|-------------------------------|
| 1. ARTICOLAZIONE PONTE SALVASPAZIO "A" | 1. SPACE-SAVING BRIDGING UNIT |
| 2. ARMADIO | 2. WARDROBE |
| 3. TERMINALE A GIORNO | 3. OPEN END UNIT |
| 4. LETTO | 4. BED |
| 5. LETTO SALVASPAZIO "A" | 5. SPACE-SAVING BED |
| 6. COMODINO | 6. BEDSIDE TABLE |
| 7. SCRIVANIA | 7. DESK |
| 8. LIBRERIA SOSPESA | 8. WALL-MOUNTED BOOKCASE |
| 9. MENSOLE | 9. SHELVES |
| 10. SEDIA | 10. CHAIR |

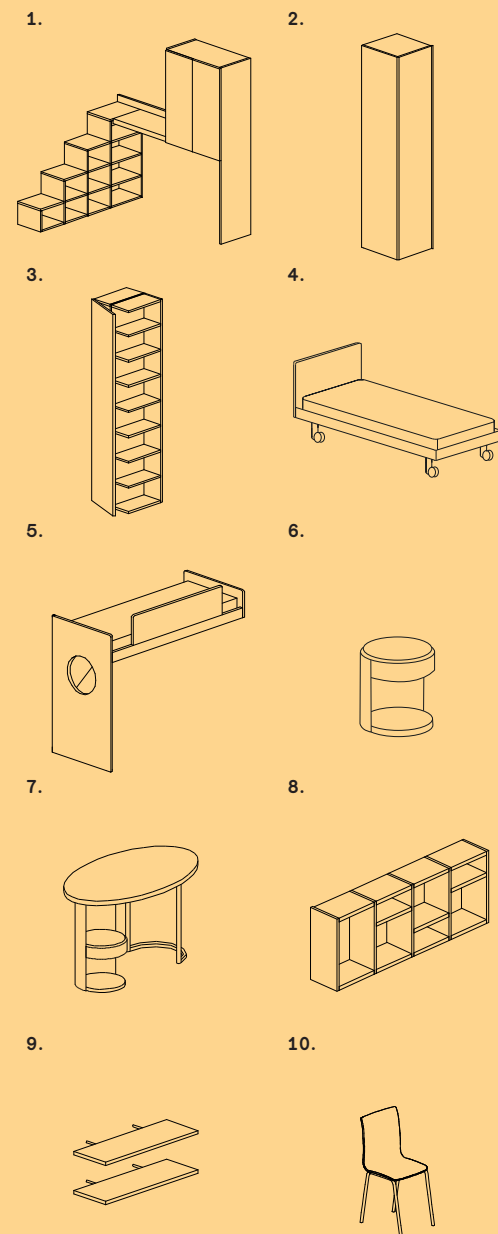

ZONA NOTTE

Letto salvaspazio "A", libreria a scaletta, letto singolo su ruote e comodino Roll. Articolazione ponte e armadio a due ante con terminale a giorno.

SLEEPING AREA

Space-saving "A" bed, bookshelf staircase, single bed with wheels, Roll bedside table. Bridging unit, hinged door wardrobe with open end unit.





ZONA STUDIO

Libreria modulare sospesa, scrivania ad isola con basamento Roll, completo di cassetto e supporto Ring in metallo. Sedia Basic.

WORKSPACE

Wall-mounted bookcase, desk with Ring and Roll bases. Basic chair.

ROOM #5

FINITURE
FINISHES



SAMARA SCURO



FOG



AVOCADO



VERDE SALVIA

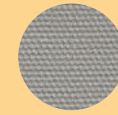

TESSUTO
GRIGIO NEUTRO

ARREDI
FURNITURE

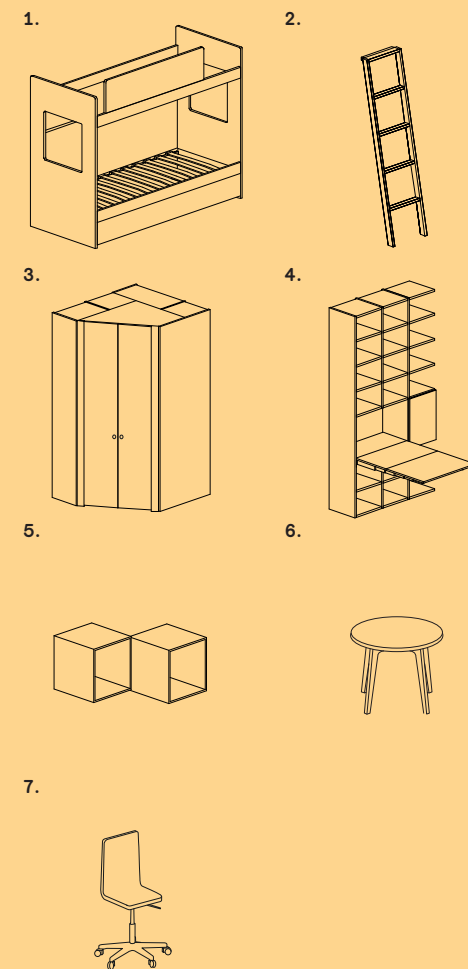
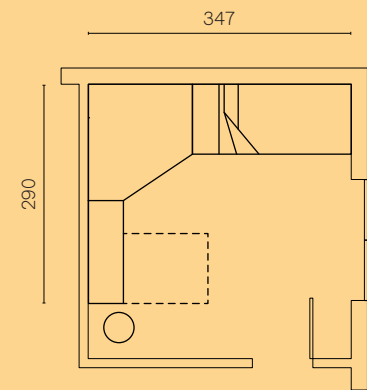

- | | |
|------------------------------------|-----------------------------------|
| 1. LETTO A CASTELLO | 1. BUNK BED |
| 2. SCALETTA | 2. STEPLADDER |
| 3. CABINA ARMADIO | 3. WALK-IN WARDROBE |
| 4. LIBRERIA CON SCRIVANIA SPECIALE | 4. BOOKCASE WITH CONVERTIBLE DESK |
| 5. CONTENITORI PENSILI | 5. WALL UNITS |
| 6. TAVOLINO WOOD | 6. WOOD BEDSIDE TABLE |
| 7. SEDIA | 7. CHAIR |



ZONA NOTTE

Letto a castello con terzo letto, contenitori pensili in folding.

SLEEPING AREA

Bunk bed with integrated extra bed, "folding" manufactured open wall units.

Con la scrivania
estraibile c'è più
spazio per giocare.

*The convertible desk allows more
space to play.*



A SINISTRA E NELLA PAGINA PRECEDENTE
 Cabina armadio al centimetro con
 maniglia Sasso, libreria con scrivania
 estraibile Homework, tavolino Wood.

AT THE LEFT AND IN THE PREVIOUS PAGE
 Walk-in wardrobe with Sasso handle,
 Homework convertible desk, Wood
 bedside table.

NELLA PAGINA PRECEDENTE
 Sedie Raz con seduta imbottita.

IN THE PREVIOUS PAGE
 Raz upholstered chairs.

ROOM #6

FINITURE
FINISHES



ROVERE CASTANO



BIANCO



CIPRIA



VERDE SALVIA



TESSUTO
GRIGIO LAVAGNA

ARREDI
FURNITURE

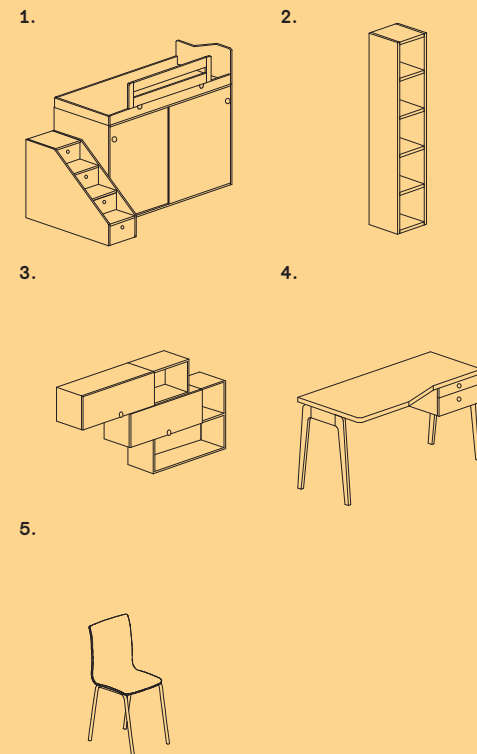
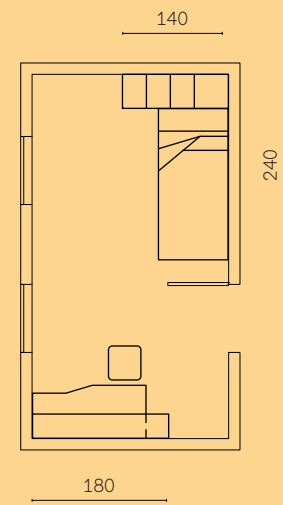

- 1. ARMADIO, LETTO RIALZATO E SCALETTA
- 2. LIBRERIA
- 3. CONTENITORI PENSILI
- 4. SCRIVANIA
- 5. SEDIA

- 1. WARDROBE, BED AND STEPLADDER
- 2. BOOKCASE
- 3. WALL UNITS
- 4. DESK
- 5. CHAIR



**ZONA STUDIO**

Libreria, contenitori pensili in folding con ante a maniglia Sasso, scrivania con basamento Wood e cassettera, sedia Basic, tavolino Wood.

WORKSPACE

Bookcase, "folding" manufactured wall units with Sasso handle, desk with Wood base and drawers, Basic chair, Wood bedside table.

ZONA NOTTE

Composizione con letto rialzato Eclisse su armadio (profondità 94,5 cm) e scaletta con cassetti.

SLEEPING AREA

Eclisse bed on wardrobe (depth 94.5 cm), staircase with drawers.



TEEN

Camere personalizzabili e flessibili, in grado di accompagnare con diverse soluzioni di design gli anni dell'adolescenza. Progettati per adattarsi ad ogni cambiamento e nuova necessità dei ragazzi, gli arredi sono in grado di soddisfare i bisogni di chi li abita creando soluzioni di contenimento e spazi multifunzionali per lo studio e il tempo libero.

Customizable and flexible bedrooms, offering smart and different solutions. These furniture pieces are designed to suit any change and every need by creating storage and multifunctional spaces for moments of studying and leisure.



IN QUESTE PAGINE

Letto a una piazza e mezza con testata imbottita, scrivania con terminale a libreria, libreria modulare con gioco di antine (apertura push-pull), armadio ad anta battente con boiserie verticale accessoriata.

IN THESE PAGES

Queen size bed with upholstered headboard, desk with integrated bookcase, bookcase with push-pull doors, hinged-door wardrobe with boiserie and accessories.



Una camera sempre
in evoluzione,
che si adatta a tutte
le esigenze.

*A bedroom always evolving,
which fits any need*



P. 56



P. 80



P. 62



P. 68

Indice
composizioni
—
Composition
index



P. 86



P. 74



P. 92



P. 98

ROOM #7

FINITURE
FINISHES



BIANCO



KASHMIR

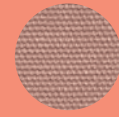

TESSUTO ROSA

ARREDI
FURNITURE

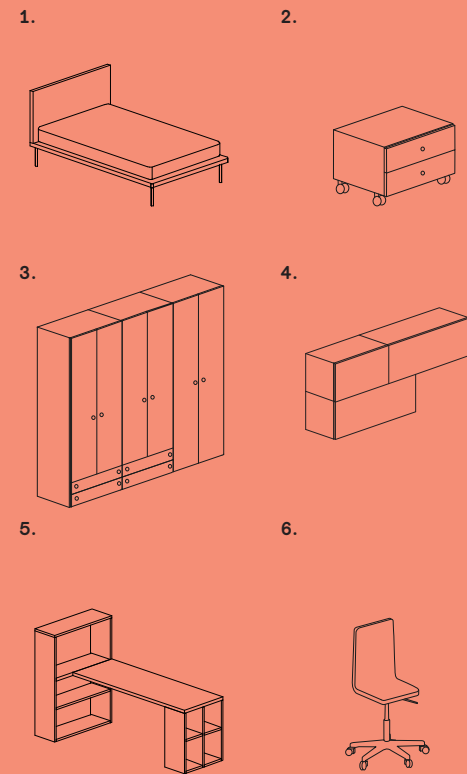
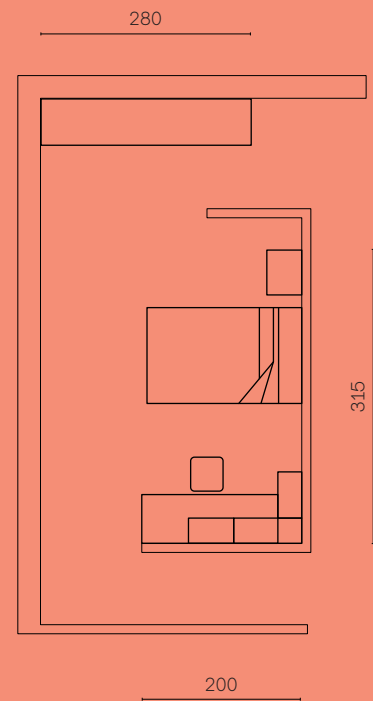

- 1. LETTO
- 2. COMODINO
- 3. ARMADIO
- 4. CONTENITORI PENSILI
- 5. LIBRERIA CON SCRIVANIA
- 6. SEDIA

- 1. BED
- 2. BEDSIDE TABLE
- 3. WARDROBE
- 4. WALL UNITS
- 5. BOOKCASE WITH DESK
- 6. CHAIR



ZONA NOTTE

Letto a una piazza e mezza con testata imbottita, armadio ad anta battente con cassetti, maniglia Pomolo.

SLEEPING AREA

Queen size bed with upholstered headboard, hinged door wardrobe with drawers, Pomolo handle.





ZONA STUDIO

Contenitori pensili in folding, libreria modulare, scrivania con terminale a libreria in appoggio su basamento bifacciale. Sedia Raz.



WORKSPACE

"Folding" manufactured wall units, modular bookcase, desk with integrated bookcase. Raz chair.

ROOM #8

FINITURE
FINISHES



BIANCO



SAMARA SCURO



ROVERE MANDORLA



GRIGIO FUMO



PETROLIO



TESSUTO
GRIGIO LAVAGNA

ARREDI
FURNITURE

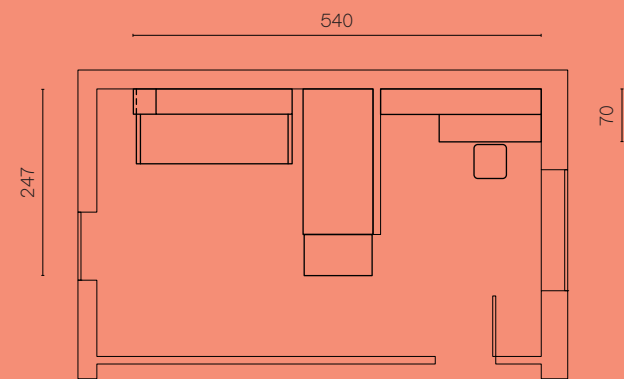

1.

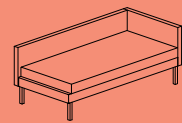

2.

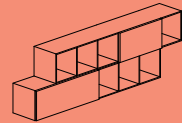

3.

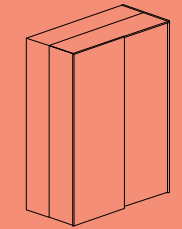

4.

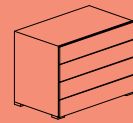

5.

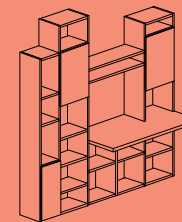

6.

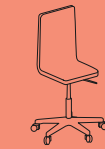

- 1. DIVANO LETTO
- 2. CONTENITORI PENSILI
- 3. CABINA ARMADIO
- 4. COMÒ
- 5. LIBRERIA CON SCRIVANIA
- 6. SEDIA

- 1. SOFA BED
- 2. WALL UNITS
- 3. WALK-IN WARDROBE
- 4. CHEST OF DRAWERS
- 5. BOOKCASE WITH DESK
- 6. CHAIR



**ZONA NOTTE**

Contenitori pensili in folding, divano letto imbottito con nuovi basamenti in metallo color ottanio, cabina armadio ad ante scorrevoli, comò a quattro cassetti.

SLEEPING AREA

"Folding" manufactured wall units, upholstered sofa bed with ottanio-coloured metal base, walk-in wardrobe with sliding doors, chest of drawers.

ZONA STUDIO

Libreria modulare con scrivania e gioco di antine (apertura push-pull), sedia Raz con seduta imbottita.

WORKSPACE

Modular bookcase with integrated desk and push-pull doors, Raz upholstered chair.



ROOM #9

FINITURE
FINISHES



BIANCO



SAMARA CHIARO

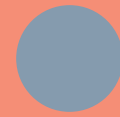

DENIM



TESSUTO
GRIGIO LAVAGNA

ARREDI
FURNITURE

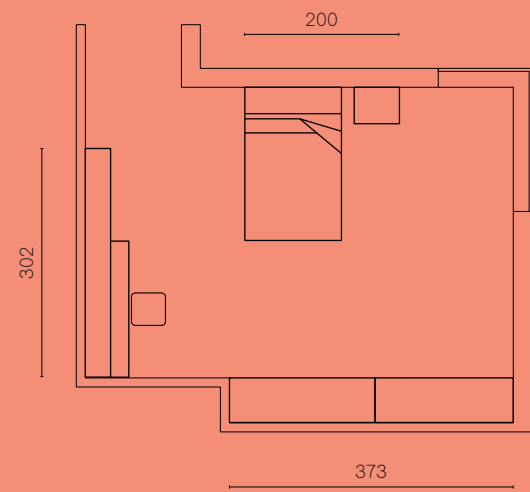

- | | |
|---------------------------|-----------------------|
| 1. LIBRERIA CON SCRIVANIA | 1. BOOKCASE WITH DESK |
| 2. SEDIA | 2. CHAIR |
| 3. LETTO | 3. BED |
| 4. COMODINO | 4. BEDSIDE TABLE |
| 5. CONTENITORI PENSILI | 5. WALL UNITS |
| 6. BOISERIE VERTICALE | 6. BOISERIE |
| 7. ARMADIO | 7. WARDROBE |

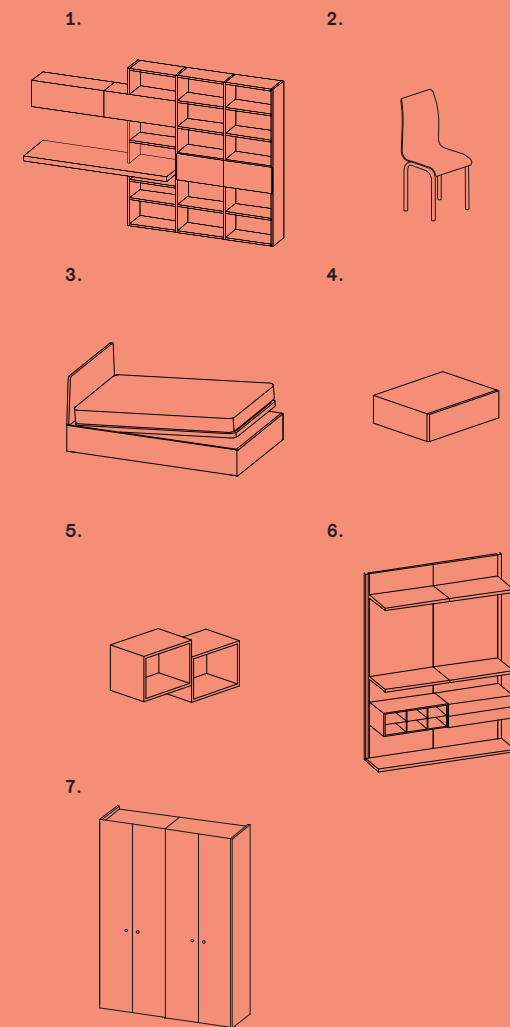

ZONA STUDIO

Libreria con gioco di antine (apertura push-pull) e scrivania King in folding (spessore 6 cm), sedia Basic con seduta imbottita.

WORKSPACE

Bookcase with push-pull doors and integrated "folding" manufactured King desk (thickness 6cm), Basic upholstered chair.



**ZONA NOTTE**

Contenitori pensili, letto contenitore Go, comodino sospeso. Armadio ad anta battente con boiserie verticale accessoriata, maniglia Pomolo.

SLEEPING AREA

"Folding" manufactured open wall units, Go storage bed, wall-mounted bedside table. Hinged door wardrobe with boiserie and accessories, Pomolo handle.

ROOM #10

FINITURE
FINISHES



FOG



LAVAGNA



GRIGIO FUMO

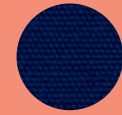

TESSUTO BLU

ARREDI
FURNITURE

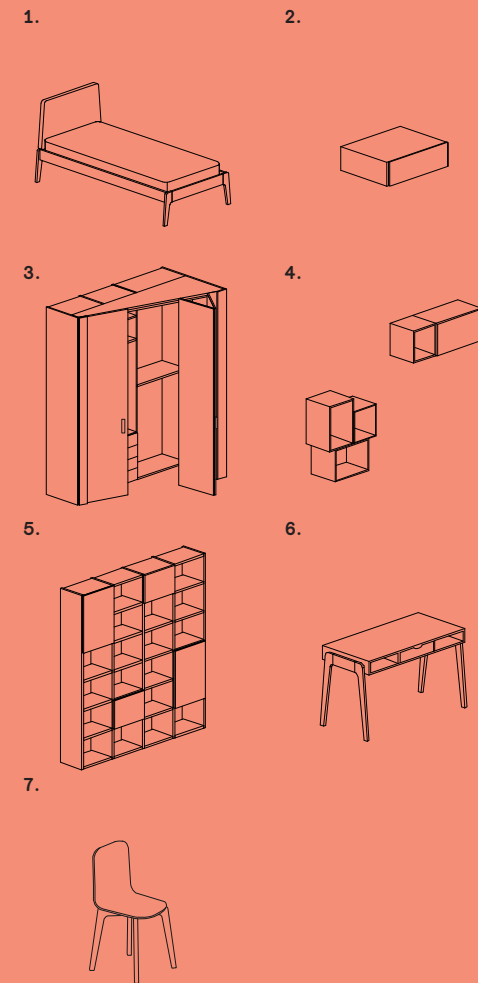
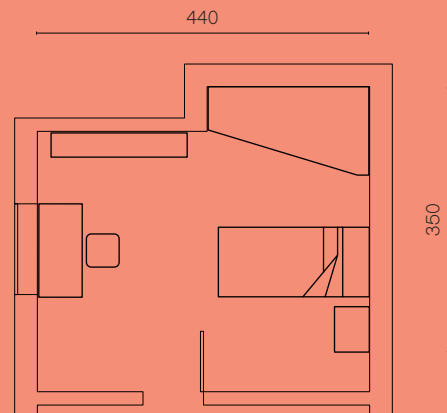

- 1. LETTO
- 2. COMODINO
- 3. CABINA ARMADIO
- 4. CONTENITORI PENSILI
- 5. LIBRERIA
- 6. SCRIVANIA
- 7. SEDIA

- 1. BED
- 2. BEDSIDE TABLE
- 3. WALK-IN WARDROBE
- 4. WALL UNITS
- 5. BOOKCASE
- 6. DESK
- 7. CHAIR



ZONA NOTTE

Cabina armadio al centimetro con maniglia Clip, contenitori pensili in folding, letto Wood, comodino sospeso.

SLEEPING AREA

Walk-in wardrobe with Clip handle, "folding" manufactured open wall units, Wood bed, wall-mounted bedside table.





Room #10



ZONA STUDIO

Scrivania con basamento Wood, sedia Wood, libreria con gioco di antine (apertura push-pull).

WORKSPACE

Desk with Wood base, Wood chair, bookcase with push-pull doors.

ROOM #11

FINITURE
FINISHES



SAMARA CHIARO



KASHMIR



VERDE OASI

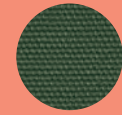

TESSUTO
VERDE BOSCO

ARREDI
FURNITURE

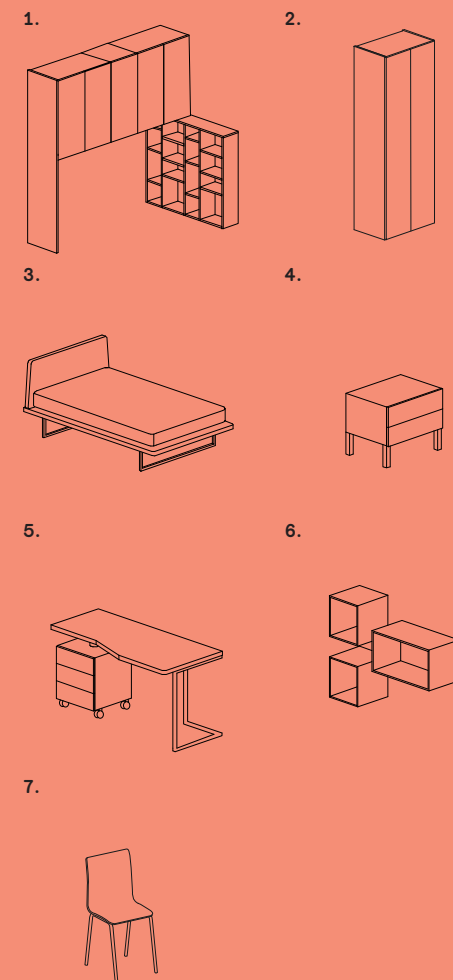
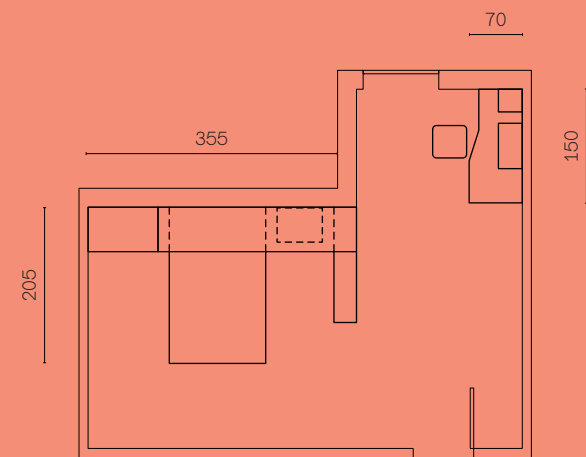

- | | |
|---|------------------------------------|
| 1. ARTICOLAZIONE PONTE
CON LIBRERIA SOTTOPONTE | 1. BRIDGING UNIT
WITH BOOKSHELF |
| 2. ARMADIO | 2. WARDROBE |
| 3. LETTO | 3. BED |
| 4. COMODINO | 4. BEDSIDE TABLE |
| 5. SCRIVANIA | 5. DESK |
| 6. CONTENITORI PENSILI | 6. WALL UNITS |
| 7. SEDIA | 7. CHAIR |



ZONA STUDIO
Scrivania con basamento Corner e cassetiera.
Contenitori pensili in folding.

WORKSPACE
Desk with Corner base and drawers,
"folding" manufactured open wall units.

Le librerie bifacciali
sono uno strumento
utile per dividere gli
spazi della camera.

*The double-sided bookcases are useful
in dividing spaces in the room.*

**ZONA NOTTE**

Armadio ad anta battente con articolazione ponte e maniglia a tutt'altezza Climb, libreria bifacciale sottoponte, comodino a due cassetti, letto Go con testata imbottita.

SLEEPING AREA

Hinged door wardrobe with bridging unit with full height Climb handle, double-sided bookcase, bedside table with drawers, Go bed with upholstered headboard.



ROOM #12

FINITURE

FINISHES



SAMARA BIANCO



BIANCO



LAVAGNA

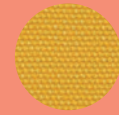

TESSUTO GIALLO



TESSUTO GRIGIO LAVAGNA

ARREDI

FURNITURE

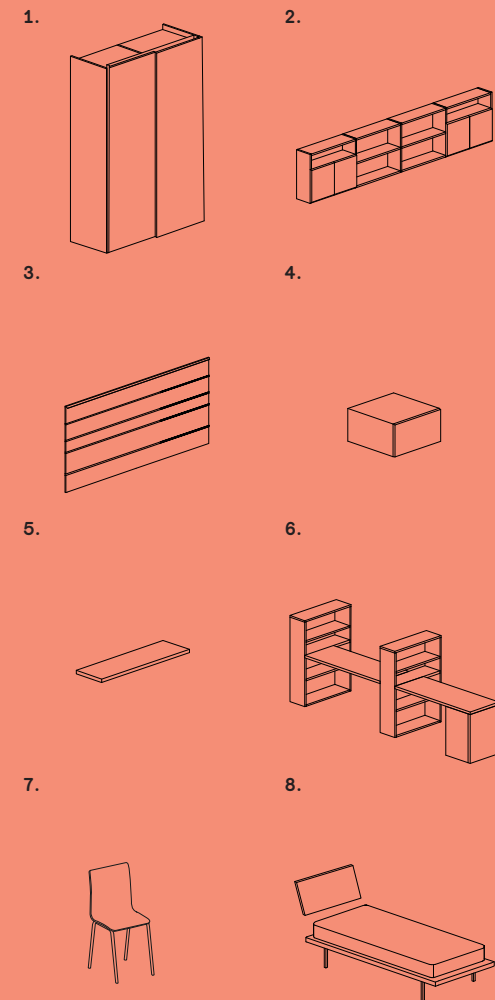
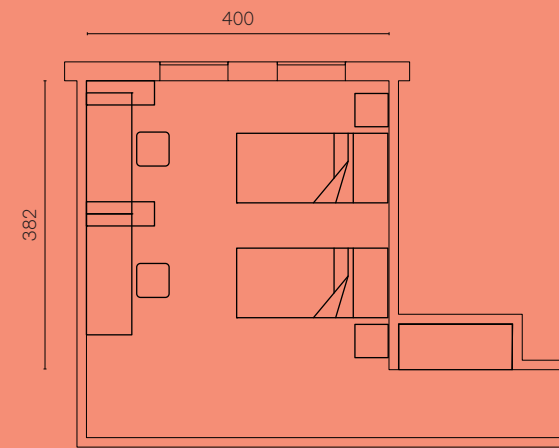

- 1. ARMADIO AD ANTE SCORREVOLI
- 2. LIBRERIA SOSPESA
- 3. BOISERIE ORIZZONTALE
- 4. CONTENITORI PER BOISERIE
- 5. MENSOLA
- 6. LIBRERIA CON SCRIVANIA
- 7. SEDIA
- 8. LETTO E CUSCINO

- 1. SLIDING DOOR WARDROBE
- 2. WALL-MOUNTED BOOKCASE
- 3. BOISERIE
- 4. STORAGE UNITS
- 5. SHELF
- 6. BOOKCASE WITH DESK
- 7. CHAIR
- 8. BED AND CUSHION



ZONA NOTTE

Contenitori pensili in folding, boiserie accessoriata con mensola, cuscini per testiera e comodini. Letti singoli, armadio ad ante scorrevoli.

SLEEPING AREA

"Folding" manufactured wall units, boiserie with shelf, headboard cushions and bedside tables. Single beds, sliding-door wardrobe.





Room #12



ZONA STUDIO

Composizione di scrivanie e librerie, sedie Basic imbottite.

WORKSPACE

Bookcases and desks, Basic upholstered chairs.

ROOM #13

FINITURE

FINISHES



BIANCO CALDO



SAMARA BIANCO



SAMARA CHIARO

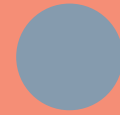

DENIM



ROSSO CORALLO



TESSUTO ROSSO

ARREDI

FURNITURE

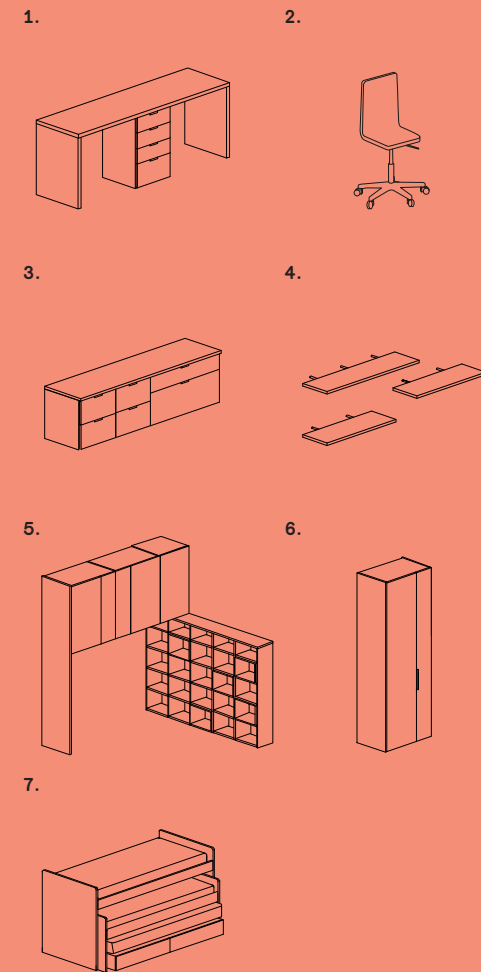
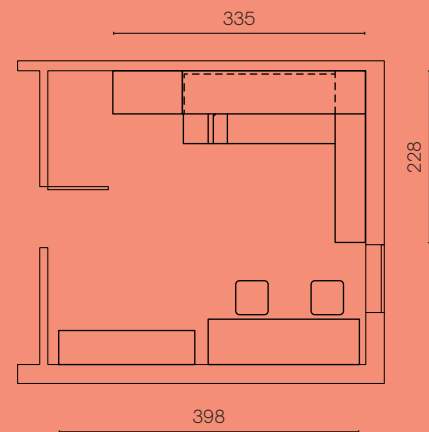

- | | |
|--|--|
| 1. SCRIVANIA | 1. DESK |
| 2. SEDIA | 2. CHAIR |
| 3. ELEMENTI A TERRA | 3. FLOORSTANDING BASE UNITS |
| 4. MENSOLE | 4. SHELVES |
| 5. ARTICOLAZIONE PONTE CON LIBRERIA SOTTOPONTE E CONTENITORI | 5. BRIDGING UNIT WITH BOOKSHELF AND WALL UNITS |
| 6. ARMADIO | 6. WARDROBE |
| 7. LETTI ESTRAIBILI | 7. PULL-OUT BEDS |

ZONA NOTTE

Armadio ad ante asimmetriche con maniglia Neck, articolazione ponte, letti estraibili, libreria modulare sottoponte con contenitori in folding.

SLEEPING AREA

Wardrobe with Neck handle, bridging unit, pull-out beds, modular boockcase with "folding" manufactured wall units.





**ZONA STUDIO**

Mensole, scrivania doppia con cassetiera, sedie Basic girevoli con seduta imbottita, elementi a terra con cassetti a maniglia Neck, maniglie Sasso a parete.

WORKSPACE

Shelves, double desk with chest of drawers, Basic upholsterd turnable chairs, floorstanding base units with drawers, Neck handle. Wall-mounted Sasso handles.



ROOM #14

FINITURE

FINISHES



SAMARA SCURO



KASHMIR



TURCHESE

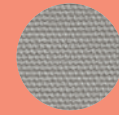

TESSUTO GRIGIO NEUTRO

ARREDI

FURNITURE

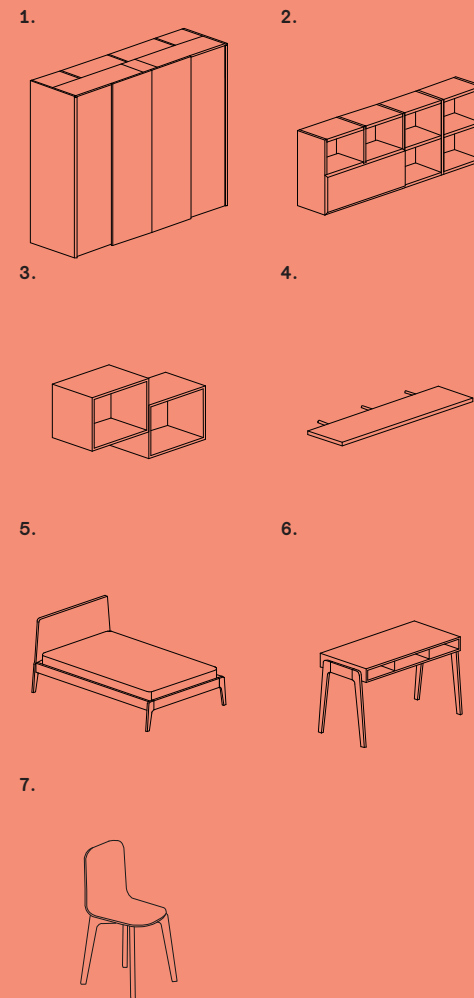
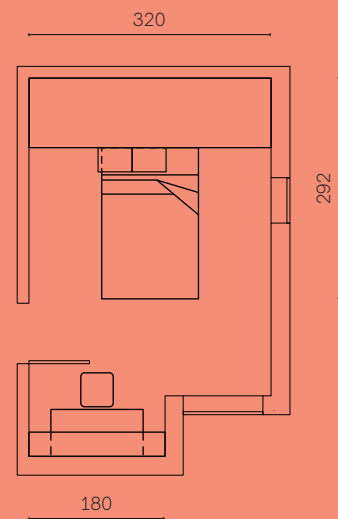

- 1. CABINA ARMADIO
- 2. LIBRERIA
- 3. CONTENITORI PENSILI
- 4. MENSOLA
- 5. LETTO
- 6. SCRIVANIA
- 7. SEDIA

- 1. WALK-IN WARDROBE
- 2. BOOKCASE
- 3. WALL UNITS
- 4. SHELF
- 5. BED
- 6. DESK
- 7. CHAIR



ZONA STUDIO

Libreria sospesa, scrivania con basamento Wood, sedia Wood con seduta imbottita.

WORKSPACE

Wall-mounted bookcase, desk with Wood base, Wood upholstered chair.

Le librerie
e i contenitori pensili
dispongono
di sistemi di fissaggio
a scomparsa.

*Bookcases and wall units have hidden
wall-mounting systems.*

**ZONA NOTTE**

Cabina armadio ad ante scorrevoli, contenitori pensili in folding, letto Wood.

SLEEPING AREA

Walk-in sliding door wardrobe, "folding" manufactured open wall units, Wood bed.

YOUNG

Ambienti polifunzionali che diventano molto di più di una semplice camera da letto, grazie ad una linea di elementi ed accessori in grado di costruire uno spazio confortevole per lo studio e il tempo libero. L'arredo si declina secondo le nuove esigenze, per creare una camera capace di integrare in una sola stanza le funzionalità di altri spazi, come lo studio e il living.

Multipurpose rooms which become more than simple bedrooms, thanks to a collection of items and accessories able to build a comfortable place for studying and for leisure time. The furnishing fits the new necessities in order to create a layout which combines in one room the functionality of different spaces, such as the home office and the living space.

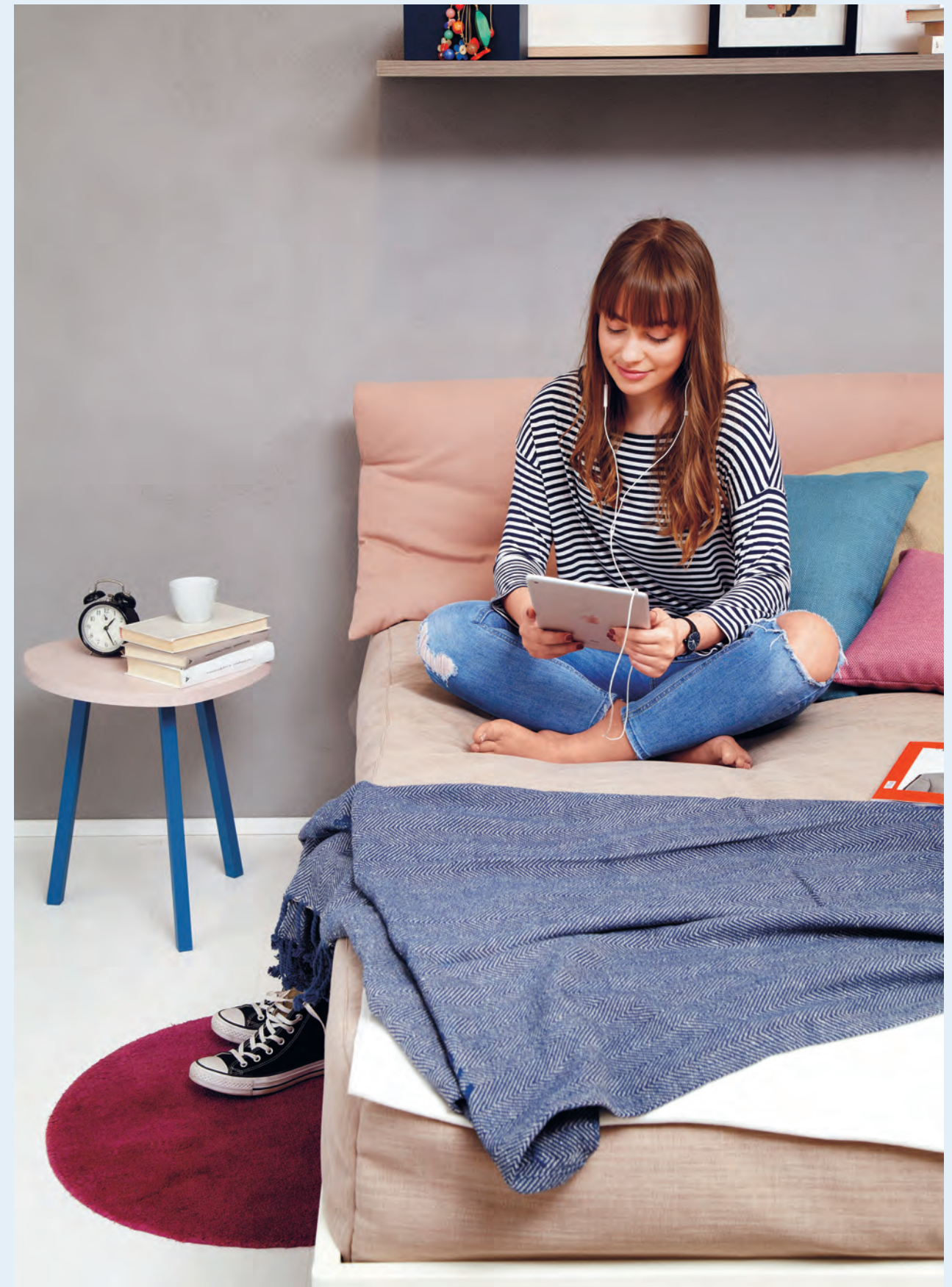

Una camera che diventa anche studio e living, per esprimere al meglio la propria autonomia.

A bedroom which becomes home office and living space, conceived to express your independence at its best.



IN QUESTE PAGINE

Mensola, letto a una piazza e mezza con cover imbottita rimovibile per testiera, tavolino Sasso. Settimino, scrivania con cassetiera, armadio ad ante scorrevoli con terminale a giorno.

IN THESE PAGES

Queen size bed with removable headboard cushion, Sasso bedside table. Chest of drawers, desk with drawers, sliding-door wardrobe with open end unit.





P. 110

**Indice
composizioni
—
Composition
index**



P. 116



P. 128



P. 134



P. 122



P. 140

ROOM #15

FINITURE
FINISHES



KASHMIR

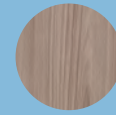

SAMARA SCURO

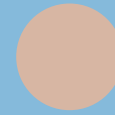

CIPRIA

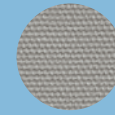

TESSUTO
GRIGIO NEUTRO

ARREDI
FURNITURE

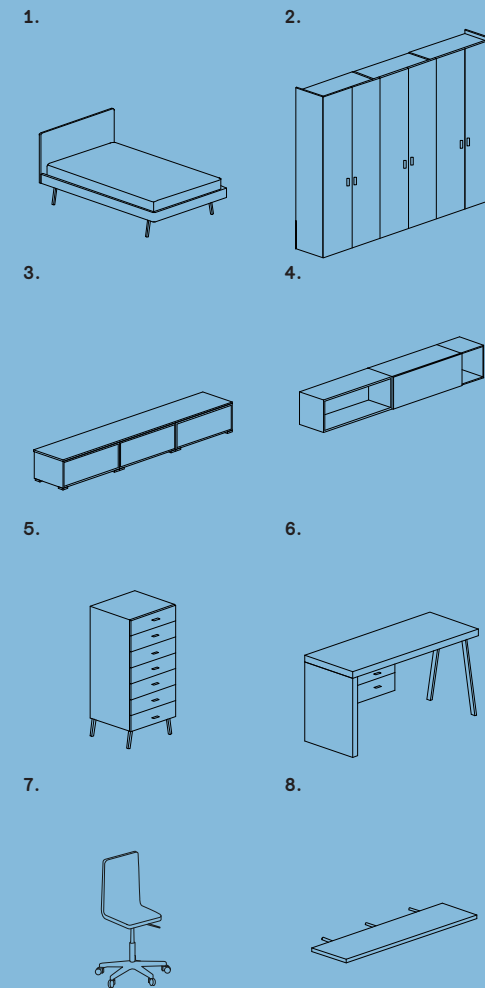
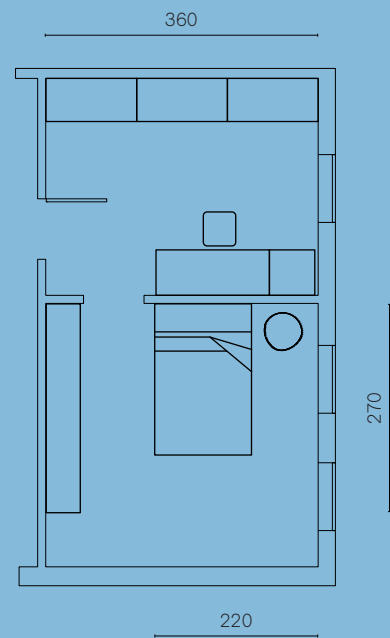

- | | |
|------------------------|-----------------------------|
| 1. LETTO | 1. BED |
| 2. ARMADIO | 2. WARDROBE |
| 3. ELEMENTI A TERRA | 3. FLOORSTANDING BASE UNITS |
| 4. CONTENITORI PENSILI | 4. WALL UNITS |
| 5. SETTIMINO | 5. CHEST OF DRAWERS |
| 6. SCRIVANIA | 6. DESK |
| 7. SEDIA | 7. CHAIR |
| 8. MENSOLA | 8. SHELF |



CONTENITORI
Composizione di elementi a terra con cassettoni e contenitori pensili in folding.

STORAGE
Floorstanding base units with drawers and "folding" manufactured wall units.

**ZONA NOTTE**

Mensola, letto a una piazza e mezza con cover imbottita rimovibile per testiera, tavolino Sasso.

SLEEPING AREA

Queen size bed with removable headboard cushion, Sasso bedside table.



**ZONA STUDIO E ARMADIATURA**

Settimino e scrivania con cassetiera con maniglia Flat mini, sedia Basic girevole con seduta imbottita. Armadio ad anta battente con maniglia Flat medium.

HOME OFFICE AND WARDROBE

Chest of drawers and desk with drawers with Flat mini handle, Basic upholstered turnable chair. Hinged door wardrobe with Flat Medium handle.

ROOM #16

FINITURE
FINISHES



BIANCO



FOG



AVOCADO



ROVERE CASTANO

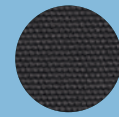

TESSUTO
GRIGIO LAVAGNA

ARREDI
FURNITURE

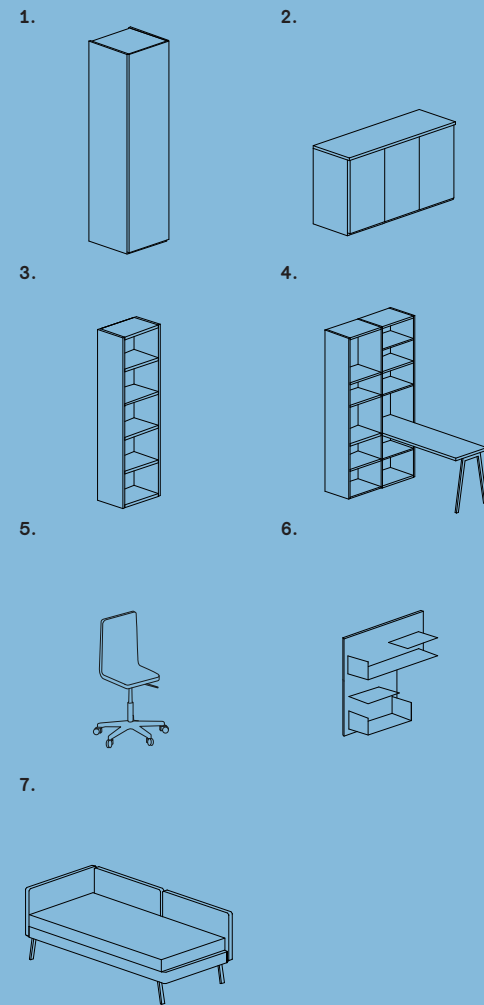
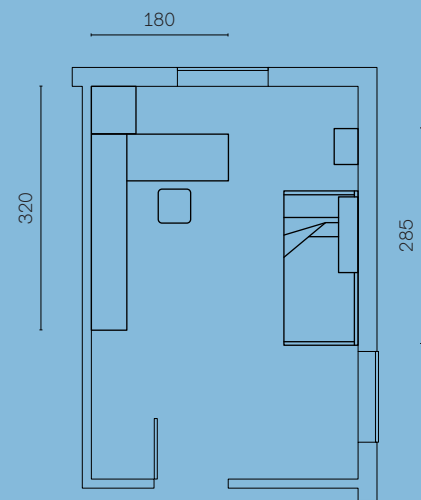

- 1. ARMADIO
- 2. MODULO BASSO CON ANTE
- 3. LIBRERIA
- 4. LIBRERIA CON SCRIVANIA
- 5. SEDIA
- 6. MENSOLE IN LAMIERA
- 7. DIVANO LETTO

- 1. WARDROBE
- 2. FLOORSTANDING BASE UNIT WITH DOORS
- 3. BOOKSHELF
- 4. BOOKSHELF WITH DESK
- 5. CHAIR
- 6. SHELVES
- 7. SOFA BED



ZONA STUDIO

Composizione di libreria e armadio con scrivania a basamento Slash, modulo basso con ante e maniglia Pomolo, mensole Tetris.

HOME OFFICE

Bookcase, wardrobe and desk with Slash base. Floorstanding base unit with doors, Pomolo handle. Tetris shelves.





Room #16



ZONA NOTTE

Contenitori pensili in folding, divano letto imbottito Aladin, mensole Tetris.

SLEEPING AREA

"Folding" manufactured open wall units, Aladin upholstered sofa bed, Tetris shelves.

ROOM #17

FINITURE
FINISHES



BIANCO



FOG

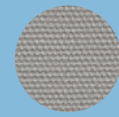

TESSUTO
GRIGIO NEUTRO

ARREDI
FURNITURE

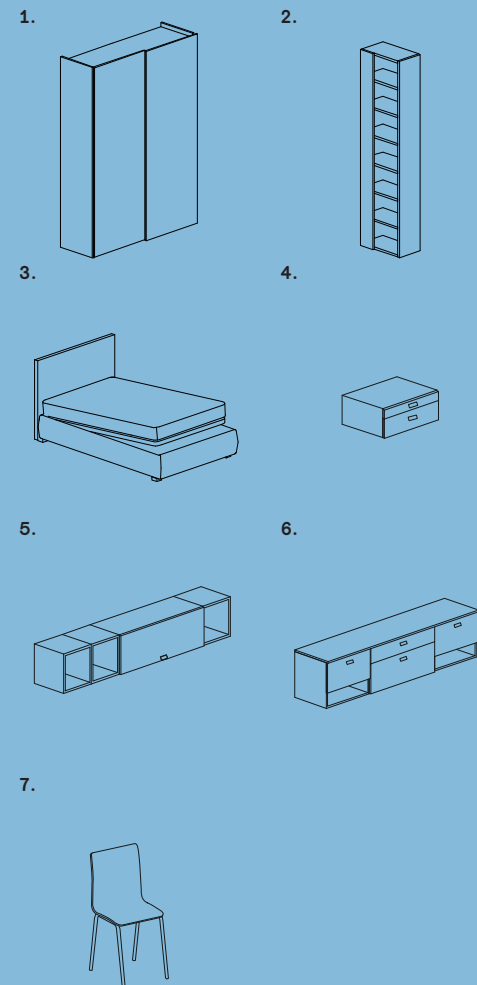
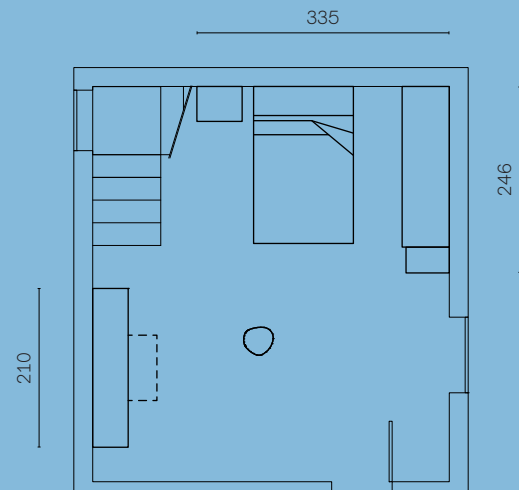

- 1. ARMADIO AD ANTE SCORREVOLI
- 2. TERMINALE A GIORNO
- 3. LETTO
- 4. COMODINO
- 5. CONTENITORI PENSILI
- 6. ELEMENTI SOSPESI
- 7. SEDIA

- 1. SLIDING DOOR WARDROBE
- 2. OPEN END UNIT
- 3. BED
- 4. BEDSIDE TABLE
- 5. WALL UNITS
- 6. WALL-MOUNTED BASE UNITS
- 7. CHAIR

ZONA STUDIO

Contenitori pensili in folding, elementi sospesi con scrivania estraibile Oplà, sedia Basic.

HOME OFFICE

"Folding" manufactured wall units, wall-mounted base units with convertible Oplà desk, Basic chair.





**ZONA NOTTE**

Comodino sospeso a due cassetti con maniglia Flat mini, letto a una piazza e mezza con testata e contenitore imbottiti, armadio ad ante scorrevoli con terminale a giorno.

SLEEPING AREA

Wall-mounted bedside table with two drawers, Flat Mini handle, queen size upholstered bed and headboard, sliding-door wardrobe with open end unit.



ROOM #18

FINITURE
FINISHES



BIANCO



KASHMIR



LAVAGNA

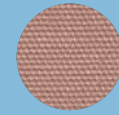

TESSUTO ROSA

ARREDI
FURNITURE

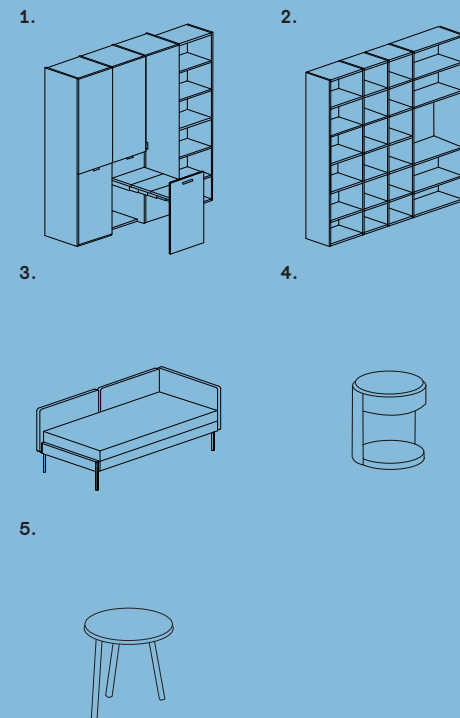
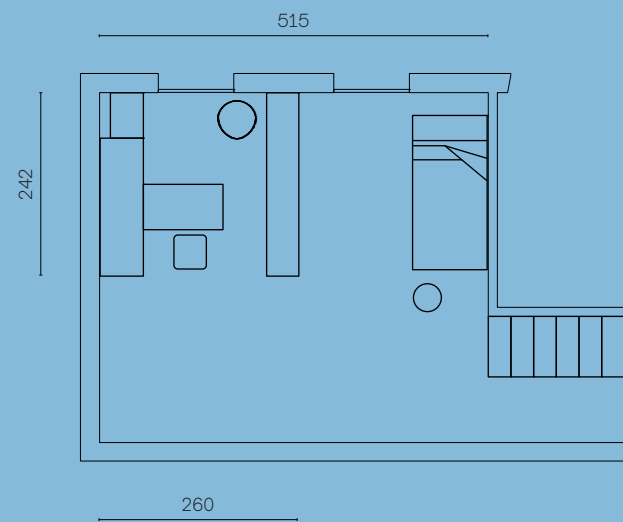

1. ARMADIO CON LIBRERIA E SCRIVANIA SPECIALE
2. LIBRERIA
3. DIVANO LETTO
4. COMODINO
5. TAVOLINO

1. WARDROBE WITH BOOKCASE AND SPECIAL DESK
2. BOOKCASE
3. SOFA BED
4. BEDSIDE TABLE
5. BEDSIDE TABLE

ZONA NOTTE

Divano letto imbottito Aladin, comodino Roll.

SLEEPING AREA

Aladin upholstered sofa bed, Roll bedside table.





**ZONA STUDIO E ARMADIATURA**

Composizione di armadi con maniglia Neck e libreria, scrivania estraibile Homework, sedia Basic girevole, libreria bifacciale.

HOME OFFICE AND WARDROBE

Wardrobes with Neck handle and bookcase, Homework convertible desk, Basic turnable chair, double-sided bookcase.



ROOM #19

FINITURE
FINISHES



BIANCO



VERDE OASI



KASHMIR



TESSUTO BIANCO

ARREDI
FURNITURE

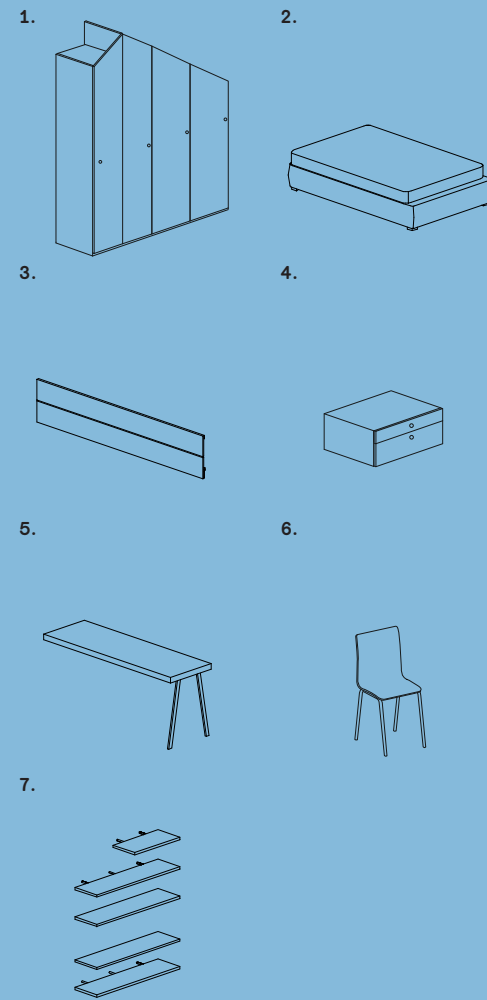
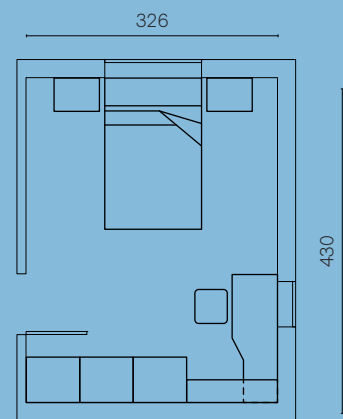

- 1. ARMADIO MANSARDATO
- 2. LETTO
- 3. BOISERIE ORIZZONTALE
- 4. COMODINI PER BOISERIE
- 5. SCRIVANIA
- 6. SEDIA
- 7. MENSOLE

- 1. WARDROBE CUT FOR SLOPING CEILING
- 2. BED
- 3. BOISERIE
- 4. BEDSIDE TABLES
- 5. DESK
- 6. SHELVES



ZONA NOTTE

Boiserie orizzontale con comodini a due cassetti, maniglia Pomolo, letto con contenitore imbottito.

SLEEPING AREA

Boiserie with 2-drawers bedside tables, Pomolo handle, upholstered platform bed.

Le boiserie possono alloggiare mensole, contenitori, comodini ed altri accessori.

Boiseries can hold shelves, storage units, bedside tables and other accessories.



**ZONA STUDIO E ARMADIATURA**

Scrivania in appoggio su mensole, sedia Basic, armadio mansardato con maniglia Pomolo.

HOME OFFICE AND WARDROBE

Shelves with integrated desk, Basic chair, wardrobe cut for sloping ceiling with Pomolo handle.

ROOM #20

FINITURE
FINISHES



FOG



LAVAGNA



ROVERE CASTANO

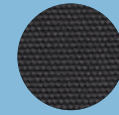

TESSUTO
GRIGIO LAVAGNA

ARREDI
FURNITURE

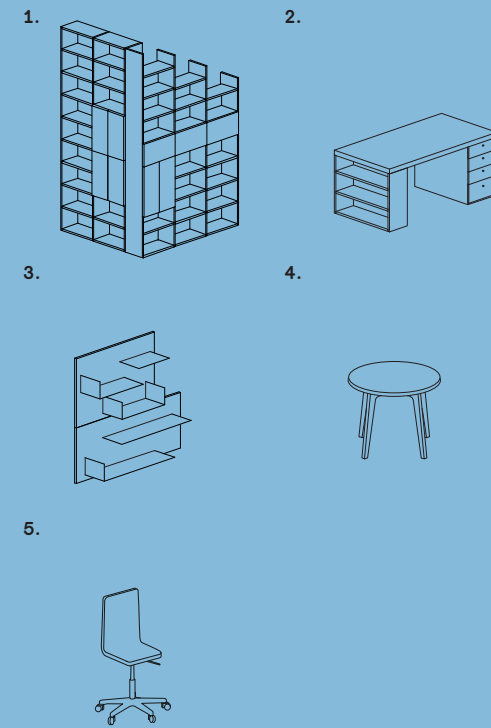
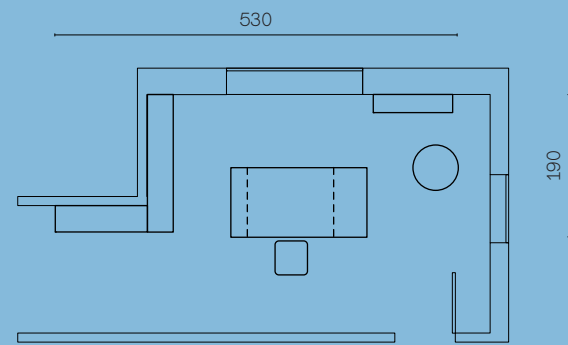

- 1. LIBRERIA AD ANGOLO
- 2. GRUPPO SCRIVANIA
- 3. MENSOLE IN LAMIERA
- 4. TAVOLINO
- 5. SEDIA

- 1. CORNER BOOKCASE
- 2. DESK WITH BOOKCASE AND CHEST OF DRAWERS
- 3. SHELVES
- 4. BEDSIDE TABLE
- 5. CHAIR



IN QUESTA COMPOSIZIONE

Libreria mansardata con gioco di antine (apertura push-pull), scrivania King in folding (spessore 6 cm) in appoggio su basamento bifacciale e cassettera, mensole Tetris, tavolino Wood, sedia Raz con seduta imbottita.

IN THIS COMPOSITION

Bookcase with push-pull doors cut for sloping ceiling, King desk (thickness 6 cm) on bookcase and chest of drawers, Tetris shelves, Wood bedside table, Raz upholstered chair.



Librerie e armadi mansardati vengono realizzati su misura per la massima flessibilità.

Bookcases and wardrobes can be cut for sloping ceilings with on-demand measures for maximum flexibility.



FOCUS ARMADI

WARDROBE

Appendice di approfondimento degli armadi FAER ad ante battente con il nuovo profilo maniglia a tutta altezza Climb. Design minimale e raffinato che si arricchisce attraverso la combinazione delle finiture disponibili. Sono a disposizione accessori per il suo interno come ripiani, portapantaloni, cesto estraibile, porta cravatte, cassettera interna e specchi.

The following pages show FAER hinged door wardrobes with the new CLIMB full height handle, applied on the edge of the door. The essential and elegant design of this closet is enriched by the combination of the available finishes. A wide range of accessories, such as shelves, shoe racks, trouser racks, tie racks, chest of drawers, mirrors, is available.



ARMADIO - L 3625 mm, H 2572 mm

Armadio ad ante battenti nella struttura Samara scuro e frontali in Kashmir con maniglia a tutt'altezza Climb in essenza.

WARDROBE - L 3625 mm, H 2572 mm

Hinged door wardrobe with structure in Samara scuro finish and Kashmir-colored doors. Climb full height handle in wood-effect finish

ARMADIO - L 3730 mm, H 2572 mm

Armadio ad ante battenti nella struttura Samara chiaro con frontali e boiserie in Bianco caldo ed accessori in Samara chiaro. Maniglia a tutt'altezza Climb in essenza.

WARDROBE - L 3730 mm, H 2572 mm

Hinged door wardrobe with Samara chiaro-colored structure and Bianco caldo-colored doors and boiserie, combined with accessories in Samara chiaro finish. Climb full height handle in wood-effect finish.





IN ALTO: ARMADIO – L 3625 mm, H 2572 mm

Armadio ad ante battenti con struttura e frontali in Samara scuro e maniglia Climb a tutt'altezza nella stessa essenza.

A SINISTRA: ARMADIO – L 2725 mm, H 2572 mm

Armadio ad ante battenti nella con struttura e frontali in Samara chiaro e maniglia a tutt'altezza Climb laccata Grigio fumo.

TOP: WARDROBE – L 3625 mm, H 2572 mm

Hinged door wardrobe with structure and doors in Samara scuro finish and full height Climb handle in the same finish.

LEFT: WARDROBE – L 2725 mm, H 2572 mm

Hinged door wardrobe with structure and doors in Samara chiaro finish and full height lacquered Grigio fumo-colored Climb handle.

FINITURE

FINISHES

Per un elenco completo, invitiamo a consultare il listino prezzi. I campioni qui riprodotti sono puramente indicativi, la rappresentazione in stampa può alterare la tonalità dei colori. Per un riferimento più fedele, consultare i campioni.

For the complete list of finishes, please see the price list. The samples hereby depicted are an approximation: the photographic representation may alter colours and tones of the materials. For a more faithful reference, please see the samples.

Finiture strutturali

Structural finishes



BIANCO

LAVAGNA

FOG



SAMARA BIANCO

SAMARA CHIARO

SAMARA SCURO

Frontali melaminici

Melamine-Coated finishes



SAMARA BIANCO

SAMARA CHIARO

SAMARA SCURO

ROVERE
MANDORLA

ROVERE CASTANO



BIANCO

BIANCO CALDO

FOG

KASHMIR



GRIGIO FUMO

LAVAGNA

Frontali melaminici

Melamine-Coated finishes



ROSSO CORALLO

AMBROSIA

AVOCADO



TURCHESE

PETROLIO

DENIM



VERDE OASI

CIPRIA

Frontali laccati

Lacquered finishes



BIANCO BIANCO CALDO FOG KASHMIR GRIGIO FUMO LAVAGNA

Frontali laccati

Lacquered finishes



OLIVA GIALLO ENERGIA OCRA ARANCIO ROSSO CORSA



CIPRIA ROSSO CORALLO AMBROSIA AVOCADO VERDE OASI

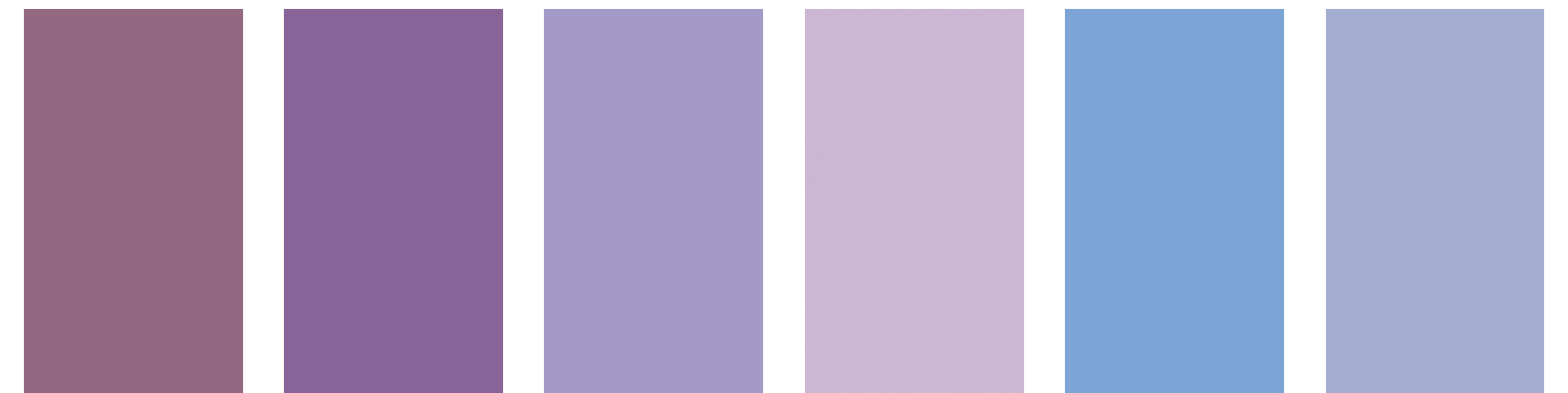

VIOLA MIRTILLO LAVANDA RUGIADA GLICINE PERVINCA



DENIM PETROLIO TURCHESE VERDE SALVIA VERDE POSITANO



OTTANIO OCEANO CORDA SAFARI CAFFÉ NERO

Tessuti

Fabrics

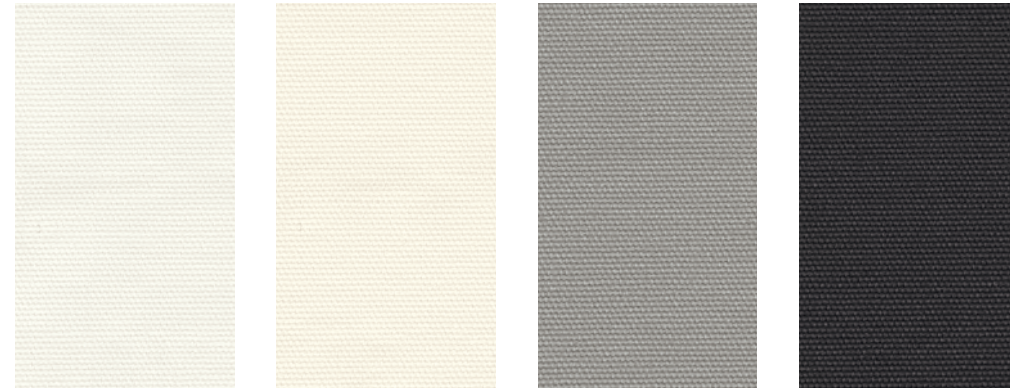

BIANCO

BIANCO CALDO

GRIGIO NEUTRO

GRIGIO LAVAGNA

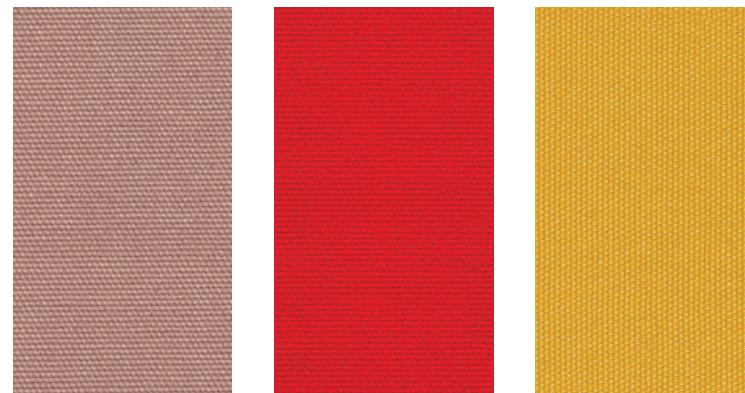

ROSA

ROSSO

GIALLO

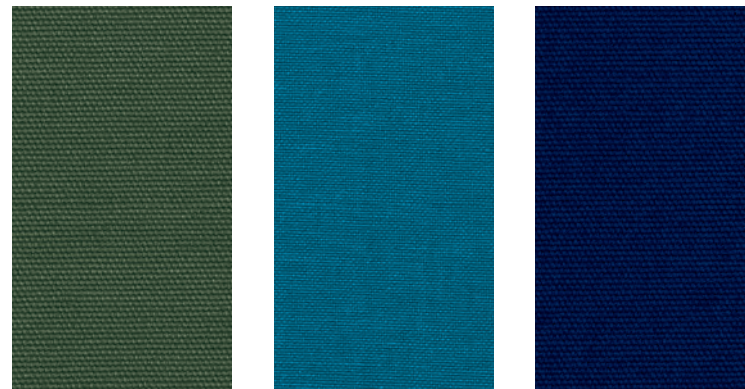

VERDE BOSCO

PETROLIO

BLU

Ecopelli

Eco-leathers

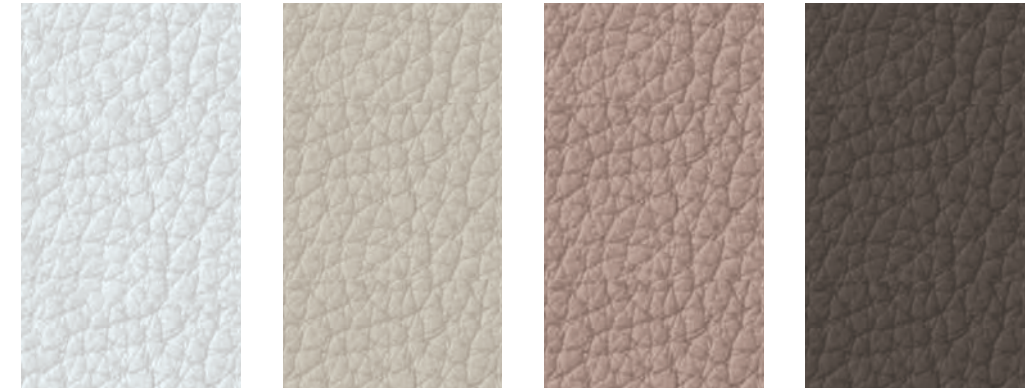

BIANCO

CORDA

TORTORA

LAVAGNA

Verniciatura metalli

Metal varnishes



BIANCO

OTTANIO

COORDINAMENTO PROGETTO

Ufficio Ricerca e Sviluppo
Lube Service & Engineering s.r.l.
Ufficio Marketing
Lube Service & Engineering s.r.l.

ART DIRECTION E PROGETTO GRAFICO

Dogtrot

PRESTAMPA

Z13

STAMPA

La Pieve Tipografica

MATERIALI IMPIEGATI:

FAER ECOLOGIC F ★★★★★
IL GRUPPO LUBE PER FAER AMBIENTI HA SCELTO DI UTILIZZARE PER I COMPONENTI COSTITUENTI I PROPRI PRODOTTI SOLO MATERIALE A MASSIMA EMISSIONE DI FORMALDEIDE CONFORMI ALLO STANDARD F★★★★ SECONDO LA NORMA JIS, CERTIFICATO DAL MINISTERO GIAPPONESE, IL PIÙ SEVERO IN MERITO ALLE NORMATIVE DI SALVAGUARDIA AMBIENTALE.





FAER AMBIENTI

Zona artigianale Capoluogo, 5
62010 Treia (MC)

Tel. 0733 218811

www.f aer.it – info@faer.it