

# COLLECTION



**IT.** Azienda familiare espressione dell'eccellenza "made in Italy", GB Group produce da 40 anni mobili da bagno e accessori di design caratterizzati da un elevato grado di personalizzazione, con conseguente rispetto degli standard tecnici ed estetici richiesti dai diversi mercati di riferimento, associato a tempi di realizzazione e consegna impareggiabili.

**FR.** *Entreprise familiale exprimant l'excellence "made in Italy", le groupe GB fabrique depuis 40 ans des meubles de salle de bains et des accessoires de design, avec un degré de personnalisation élevé, qui se conforme aux normes techniques et esthétiques requises par les différents marchés de référence associés à délais de production et de livraison sans égale.*

**EN.** *Family-owned company expression of excellence "made in Italy", GB Group has been producing bathroom furniture and design accessories for 40 years, with a high degree of customization, with consequent compliance with the technical and aesthetic standards required by the various reference markets associated with unparalleled delivery and realization times.*

**DE.** *Familienbetrieb, Ausdruck von "Made in Italy" Exzellenz, GB Group produziert Badmöbel und Design-Zubehör seit 40 Jahren, gekennzeichnet durch einen hohen Grad an Anpassung, mit konsequenter Einhaltung der technischen und ästhetischen Standards von den verschiedenen Referenzmärkten, damit verbunden zu konkurrenzlosen Produktions- und Lieferzeiten.*

**ES.** *Expresión de excelencia de la empresa familiar "made in Italy", el Grupo GB ha producido durante más de 40 años muebles de baño y accesorios de diseño caracterizados por un alto grado de personalización, con el consiguiente cumplimiento de los estándares técnicos y estéticos requeridos por los diversos mercados de referencia asociados con tiempos de producción y entrega inigualables.*

**RU.** *Семейная компания GB Group, выражающая превосходство "made in Italy", в течение 40 лет выпускает мебель для ванных комнат и дизайнерские аксессуары характеризующихся высокой степенью персонализации с последующим соблюдением технических и эстетических стандартов, требуемых на разных целевых рынках, связанных с беспрецедентными сроками производства и доставки.*

# INDICE

Index / Index / Index / Índice / Содержание

 SILK	4
 EXTREME	36
 WILD	68
 UNDERGROUND	96
 MOON	122
 ONDA	274
 COMPACT	292



## ■ SILK

**IT.** Silk è un progetto che definisce un nuovo concetto di essenzialità formale, legato alla matericità della presa maniglia.

**FR.** Silk est un projet qui définit un nouveau concept d'essentialité formelle, lié à la matérialité de la prise de main.

**EN.** Silk is a project that defines a new concept of formal essentiality, connected to the materiality of the integrated pull.

**DE.** Silk ist ein projekt, das ein neues konzept der formalen wesentlichkeit definiert, das mit der materialität der gefrästen griffmulde verbunden ist.

**ES.** Silk es un proyecto que define un nuevo concepto de esencialidad formal, relacionado a la materialidad del tirador integrado.

**RU.** Silk — это проект, определяющий новую концепцию формальной необходимости, связанной с весомостью встроенной ручки.

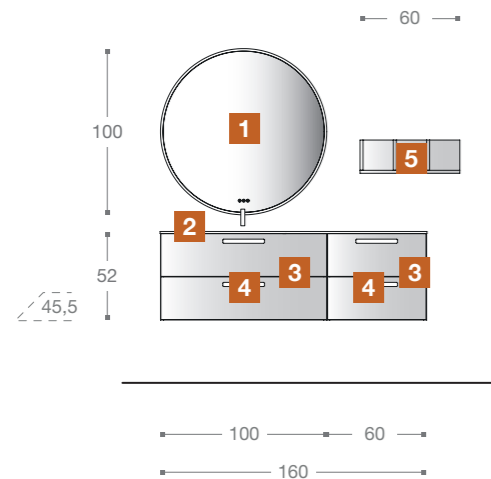

- 1** ALFA

---

- 2** **TECNOMOOD - LB855 - NCS: S5020 R90B**  
*Opaco / Mat / Matt / Mate / Матовый*

---

- 3** **NCS: S5020 R90B**  
*Opaco / Mat / Matt / Mate / Матовый*

---

- 4** **932 ROVERE ORO**

---

- 5** **NCS: S5020 R90B**  
*Opaco / Mat / Matt / Mate / Матовый*





**IT.** Nella pagina a fianco dettaglio top in Tecnomood con vasca integrata LB855 L.48 cm e base con cassetto aperto con divisori in metallo serie Row. Sopra dettaglio portlavabo laccato opaco Ncs con presa maniglia sagomata a 45° e inserto in legno 932 Rovere Oro.

**FR.** Dans la page à côté le détail du plan en tecnomood avec vasque moulée LB855 L.48cm et élément bas avec tiroir ouvert avec les séparateurs en métal de la série Row. En haut le détail du meuble sous-vasque laqué mat Ncs avec prise de mains biseauté à 45 degrés et fond arrière en bois 932 Rovere oro.

**EN.** On the opposite page a detail of the Tecnomood top with integrated basin LB855 L.48 cm and base unit with open drawer with metal dividers from the Row series. Above a detail of a NCS matt lacquered wash-basin unit with 45° shaped integrated pull and wood insert in 932 Rovere Oro.

**DE.** Auf der gegenüberliegenden Seite ist ein Detail der Tecnomood Platte mit integriertem Waschbecken LB855 L.48 cm und Unterschrank mit offener Schublade mit Metalltrenntege der Serie Row. Oben Detail des matt lackierten NCS-Waschtisches mit 45° gefräster Griffmulde und Einsatz aus Holz 932 Rovere Oro.

**ES.** En la página al lado, detalle encimera en Tecnomood con cuba integrada LB855 A.48 cm y módulo con cajón abierto con divisorios de metal serie Row. Arriba detalle portlavabo lacado mate NCS con tirador integrado perfilado a 45° e inserción de madera 932 Rovere Oro.

**RU.** На противоположной странице деталь топа из Tecnomood с интегрированной мойкой LB855 шир.48 см и тумба с открытым ящиком и с металлическими разделителями серии Row. Вверху деталь тумбы под раковину матовый лак Ncs с фрезерованной ручкой под углом 45° и вставкой из натурального дерева Rovere Oro 932.

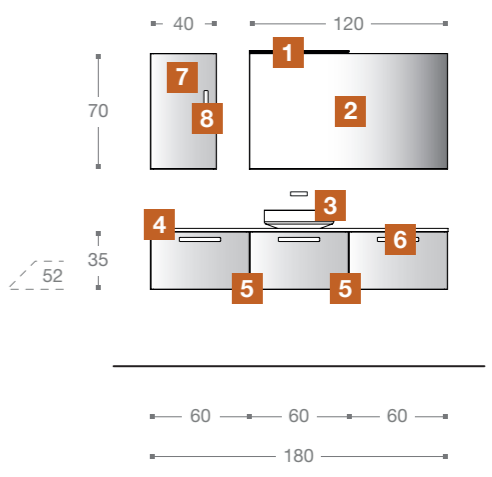

- 1** SLIM - H58.600

---

- 2** SPECCHIO FILO LUCIDO  
*Miroir simple / Simple mirror / Spiegel / Espejo canto pulido / Зеркало с полированными краями*

---

- 3** IRIS - TECNOMAT - 433 NERO  
*Opaco / Mat / Matt / Matt / Mate / Матовый*

---

- 4** TECNOGRES - 335 SHARA NOIR

---

- 5** 433 NERO  
*Opaco / Mat / Matt / Matt / Mate / Матовый*

---

- 6** 500 GOLDEN SATIN

---

- 7** 433 NERO  
*Opaco / Mat / Matt / Matt / Mate / Матовый*

---

- 8** 500 GOLDEN SATIN



**IT.** Frontale e presa maniglia sagomati a 45° sono le particolarità della serie Silk; le vediamo sopra nel dettaglio della base con cassetto aperto e cassetto interno.

**FR.** La façade et la prise de mains biseautéés à 45° sont les caractéristiques de la collection Silk. On les voit en haut dans le détail de l'élément bas avec tiroir ouvert et tiroir à l'anglaise à l'intérieur.

**EN.** The special features of this Silk series are the front and the integrated pull shaped at 45°; we can see a detail above of the base with open drawer and inner drawer.

**DE.** Die Besonderheiten der Serie Silk sind die im 45°-Winkel geformte Front und der Griffmulde, die wir oben im Detail des Unterschrankes mit offener Schublade und Innenschublade sehen.

**ES.** Frontal y tirador integrado perfilado a 45° son las particularidades de la serie Silk; las vemos arriba en el detalle del módulo con cajón abierto y cajón interior.

**RU.** Особенностью серии Silk является фасад и фрезерованная ручка под углом 45°; их видно выше в деталях тумбы с открытым ящиком и внутренним ящиком.

**IT.** Pensile L.40 H.70 P.16 cm, laccato opaco 433 Nero e presa maniglia finitura 500 Golden Satin.

**FR.** Armoire L.40 H.70 P.16 cm, laqué mat 433 Nero et prise de mains avec fonds arrière Golden Satin 500.

**EN.** Wall unit W.40 H.70 D.16 cm, 433 black matt lacquered and integrated pull in 500 Golden Satin finish.

**DE.** Hängeschrank B.40 H.70 T.16 cm, 433 Schwarz matt lackiert und Griffausführung 500 Golden Satin.

**ES.** Armario A.40 H.70 P.16 cm, lacado mate 433 Nero y tirador integrado acabado 500 Solder Satin.

**RU.** Шкафчик шир.40 выс.70 гл.16 см в матовом лаке 433 Nero и фрезерованная ручка с отделкой 500 Golden Satin.

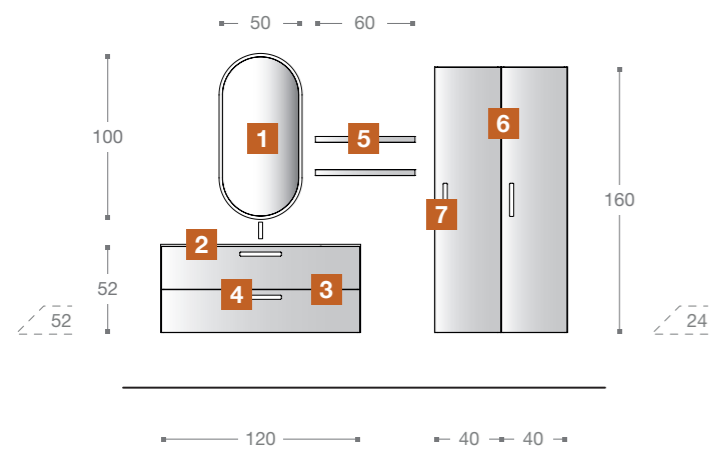

- 1** SHADE

---

- 2** TECNOLITE - LB455

---

- 3** 407 AGATA  
*Opaco / Mat / Matt / Mate / Матовый*

---

- 4** 407 AGATA  
*Opaco / Mat / Matt / Mate / Матовый*

---

- 5** SELECTA - 407 AGATA  
*Opaco / Mat / Matt / Mate / Матовый*

---

- 6** 407 AGATA  
*Opaco / Mat / Matt / Mate / Матовый*

---

- 7** 407 AGATA  
*Opaco / Mat / Matt / Mate / Матовый*







**IT.** A fianco dettaglio della mensola Selecta, un estruso in alluminio laccato opaco 407 Agata. Nella pagina precedente particolare colonne con anta aperta sagomata a 45°.

**FR.** A côté détail de l'étagère Selecta, en aluminium laqué mat 407 Agata mat. Dans la page précédente, le détail des colonnes avec porte biseautée à 45 degrés.

**EN.** Next page detail of the Selecta shelf, a matt lacquered 407 Agata extruded aluminum. On the previous page detail of columns with 45° shaped open door.

**DE.** Seitliches Detail des Regals Selecta, ein matt lackiertes 407 Agata Stangpressprofil. Auf der vorhergehenden Seite Detail der Hochschränke mit offener Tür in 45°-Form.

**ES.** Al lado detalle de la repisa Selecta, un extruido de aluminio lacado mate 407 Agata. En la página anterior particular columna con puerta abierta perfilada a 45°.

**RU.** Рядом деталь полки Selecta из экструдированного алюминия в матовом лаке 407 Agata. На предыдущей странице деталь колонны с открытыми дверцами под углом 45°.

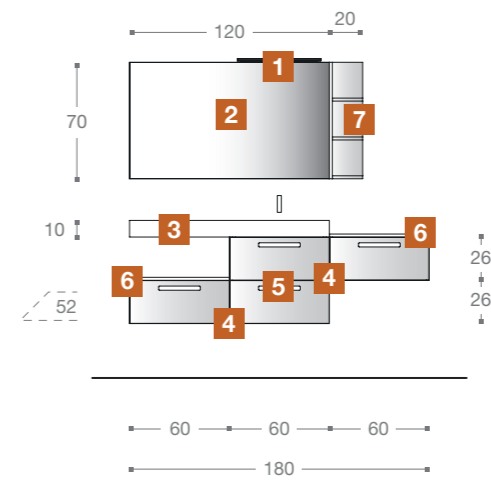

- 1** SURA - BIANCO  
*Blanc / White / Weiss / Blanco / Белый*
- 2** SPECCHIO FILO LUCIDO  
*Miroir simple / Simple mirror / Spiegel / Espejo canto pulido / Зеркало с полированными краями*
- 3** TECNOLAM - VA013 - 254 ROVERE SLAVONIA
- 4** 416 CRETA  
*Opaco / Mat / Matt / Matt / Mate / Матовый*
- 5** 501 BRUNISHED BRASS
- 6** 416 CRETA  
*Opaco / Mat / Matt / Matt / Mate / Матовый*
- 7** 416 CRETA  
*Opaco / Mat / Matt / Matt / Mate / Матовый*



**METALLO**

*Métal / Metal / Metal / Metal / Металл*

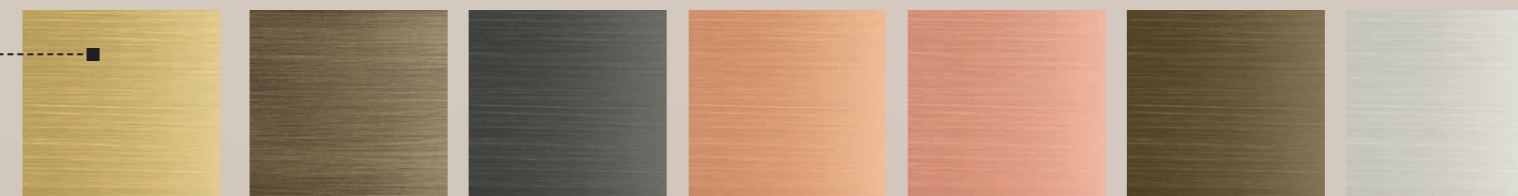

500 GOLDEN SATIN    501 BRUNISHED BRASS    502 IRON BLACK    503 COPPER SATIN    504 PINK GOLD    505 OLD BRASS    506 INOX SATIN

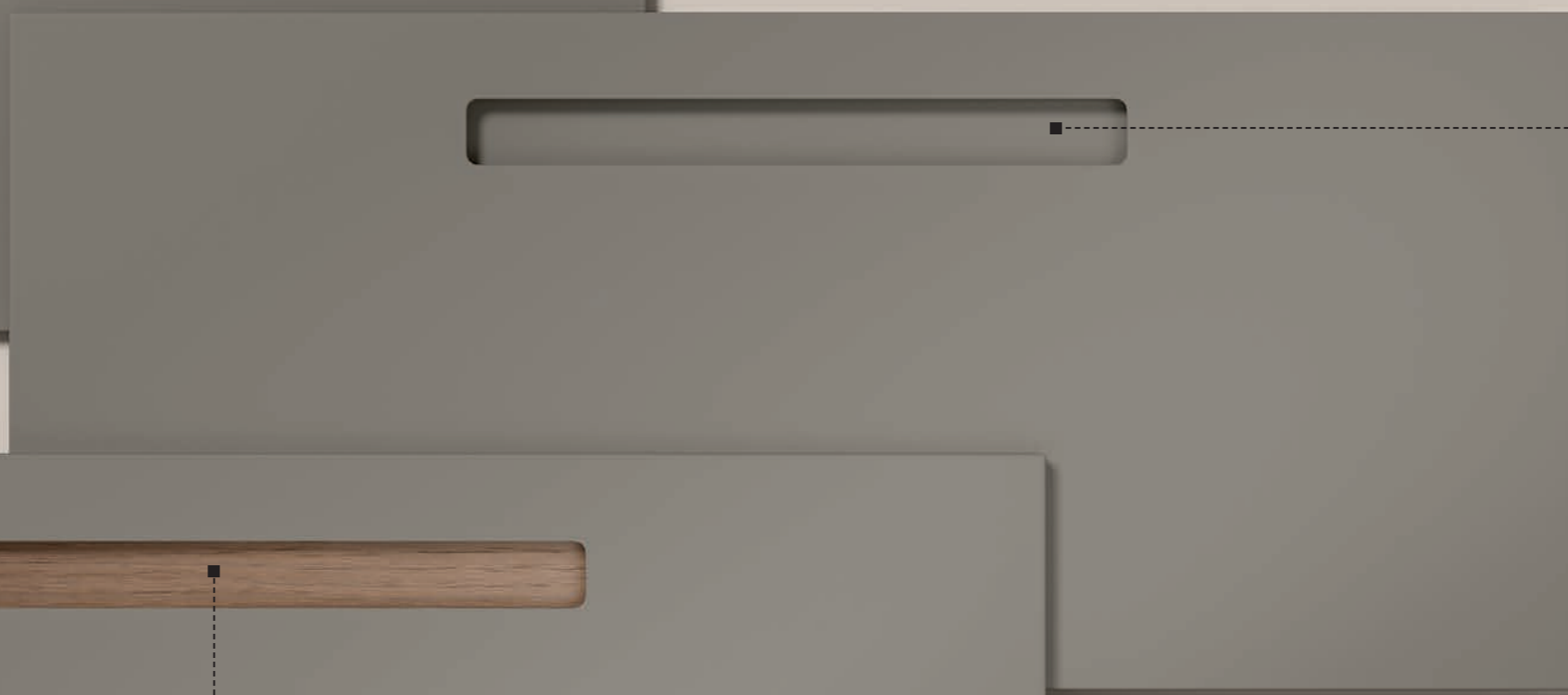

**COLORI OPACHI - NCS**

*Couleurs mates - Ncs / Matt - Ncs colours / Matte - Ncs Farben / Colores Mates - Ncs / Матовые - Ncs цвета*

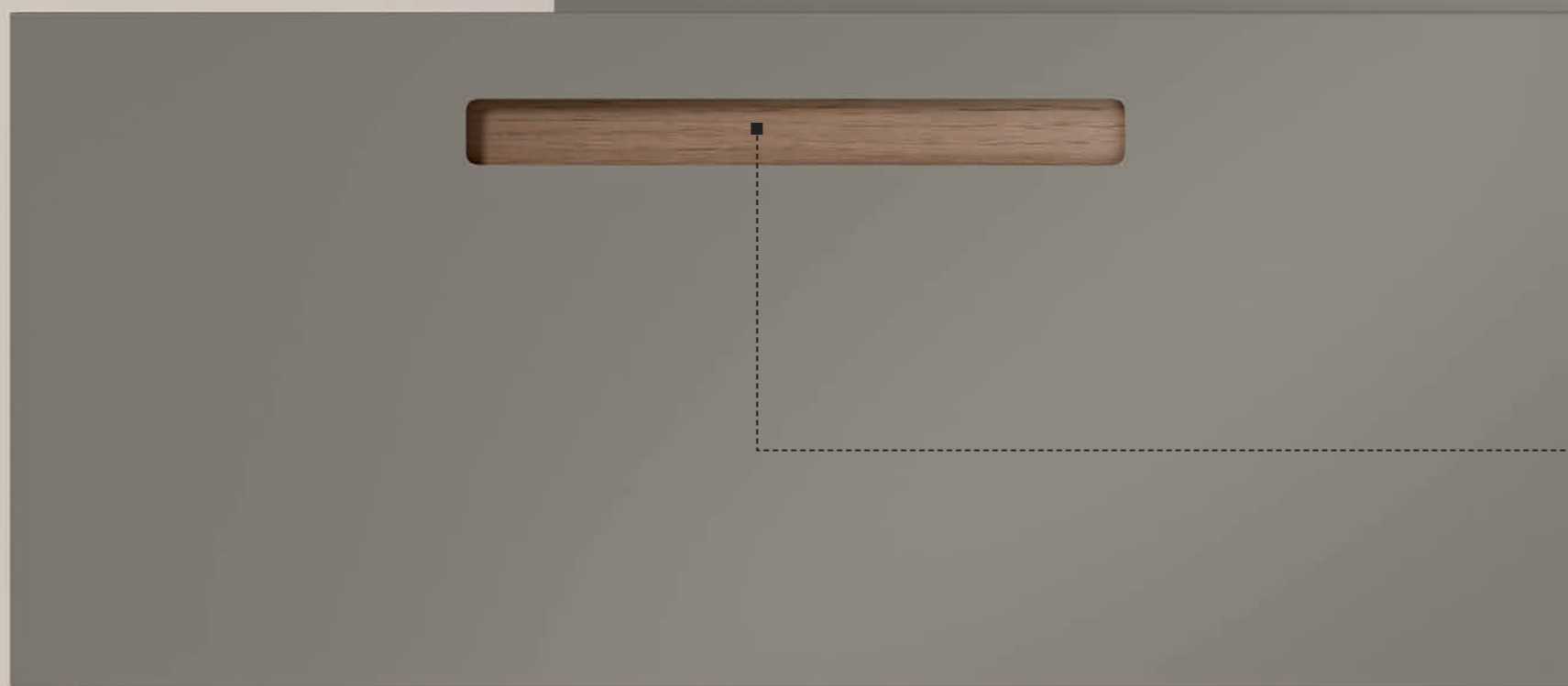

**LEGNO**

*Bois / Woods / Hölzer / Maderas / Варианты Дерева*



933 NOCE CANALETTO    932 ROVERE ORO    931 ROVERE TERMOCOTTO

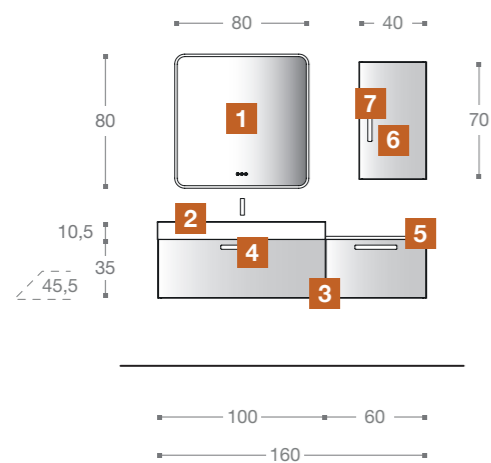

- 1** DOT

---

- 2** TECNOMAT - TNB050

---

- 3** NCS: S 3005-G80Y  
*Opaco / Mat / Matt / Mate / Матовый*

---

- 4** NCS: S 3005-G80Y  
*Opaco / Mat / Matt / Mate / Матовый*

---

- 5** NCS: S 3005-G80Y  
*Opaco / Mat / Matt / Mate / Матовый*

---

- 6** NCS: S 3005-G80Y  
*Opaco / Mat / Matt / Mate / Матовый*

---

- 7** NCS: S 3005-G80Y  
*Opaco / Mat / Matt / Mate / Матовый*





**IT.** Sopra particolare base laccata Ncs con cassetto aperto. Nella pagina a fianco specchio Dot retroilluminato luce Led con tre tasti touch: on/off, dimmer, antiappannamento.

**FR.** En haut, détail de l'élément laqué Ncs avec tiroir ouvert. Dans la page à côté le miroir Dot rétroéclairé à lumière Led avec 3 boutons touch: on/off, dimmer, antibuée.

**EN.** Above a detail of a NCS lacquered base unit with open drawer. On the opposite page Dot mirror backlit Led light with three touch buttons: on/off, dimmer, demister pad.

**DE.** Oben ein Detail vom NCS lackiert Unterschränk mit offenen Schublade. Auf der gegenüberliegenden Seite Spiegel Dot hinterleuchtete LED-Licht mit drei Touch-Tasten: ein / aus, Dimmer, Anti-Beschlag System.

**ES.** Arriba particular módulo lacado NCS con cajón abierto. En la página al lado espejo Dot retroiluminado luz Led con tres botones touch: on/off, dimmer, antivaho.

**RU.** Вверху деталь лакированной тумбы с открытым ящиком цвет Ncs. На противоположной странице зеркало Dot со светодиодной подсветкой и тремя сенсорными кнопками: вкл./выкл., затемнение, защита от запотевания.



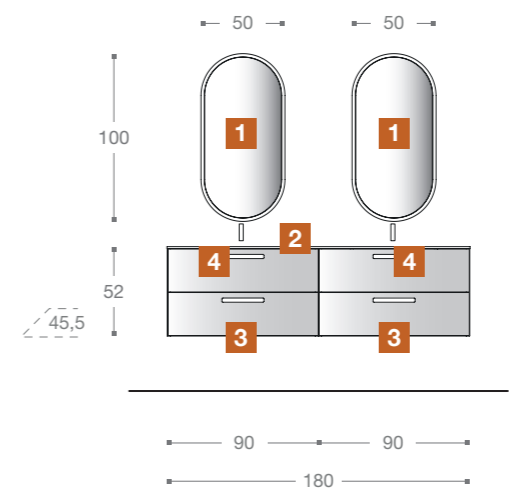

- 1** SHADE

---

- 2** **TECNOMOOD - LB574 - 401 FUMO**  
*Opaco / Mat / Matt / Matt / Mate / Матовый*

---

- 3** **401 FUMO**  
*Opaco / Mat / Matt / Matt / Mate / Матовый*

---

- 4** **502 IRON BLACK**



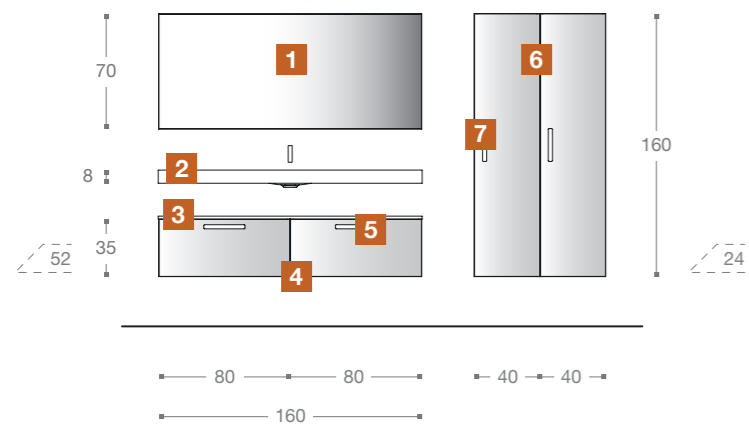

- 1** EDEN

---

- 2** TECNOMAT - VA023

---

- 3** 415 SALVIA  
*Opaco / Mat / Matt / Mate / Матовый*

---

- 4** 415 SALVIA  
*Opaco / Mat / Matt / Mate / Матовый*

---

- 5** 504 PINK GOLD

---

- 6** 415 SALVIA  
*Opaco / Mat / Matt / Mate / Матовый*

---

- 7** 504 PINK GOLD





**IT.** Composizione con top in Tecnomat e vasca a scivolo VA023; base laccata opaco 415 Salvia con inserto presa maniglia finitura 504 Pink Gold.

**FR.** Ensemble avec plan en tecnomat et vasque à caniveau VA023; Élément bas laqué mat 415 Salvia avec fond arrière de la prise de mains en Pink Gold 504.

**EN.** Composition with Tecnomat top and sloping basin VA023; 415 Salvia matt lacquered base unit with integrated pull in 504 Pink Gold finish.

**DE.** Komposition mit Tecnomat-Platte und VA023-mit Schlitzablauf; matt lackierter Unterschrank 415 Salvia mit Griffesatz in 504 Roségold.

**ES.** Composición con encimera en Tecnomat con cuba soave VA023; módulo lacado mate 415 Salvia con inserción tirador integrado 504 Pink Gold.

**RU.** Композиция с топом из Tecnomat и гладкой мойкой VA023; тумба в матовом лаке 415 Salvia с фрезерованной ручкой со вставкой в отделке 504 Pink Gold.



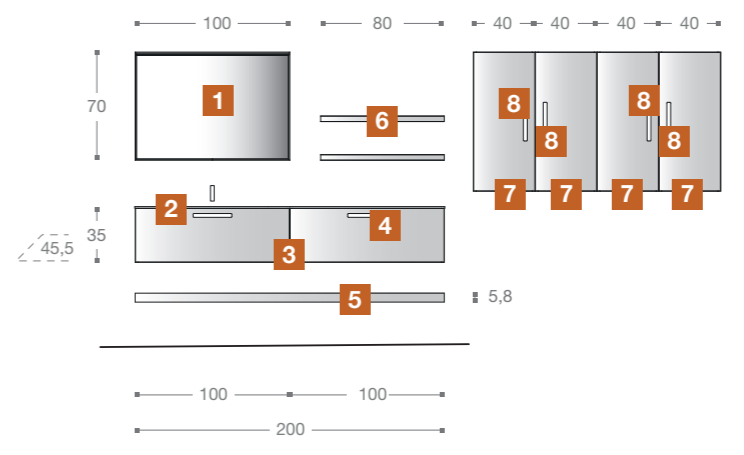

- 1** BRICK - 416 CRETA  
*Opaco / Mat / Matt / Matt / Mate / Матовый*
- 2** TECNOGRES - LV895 - 323 PIETRA GREY
- 3** 416 CRETA  
*Opaco / Mat / Matt / Matt / Mate / Матовый*
- 4** 931 ROVERE TERMOCOTTO
- 5** 416 CRETA  
*Opaco / Mat / Matt / Matt / Mate / Матовый*
- 6** SELECTA - 416 CRETA  
*Opaco / Mat / Matt / Matt / Mate / Матовый*
- 7** 416 CRETA  
*Opaco / Mat / Matt / Matt / Mate / Матовый*
- 8** 931 ROVERE TERMOCOTTO



**PORTALAVABI**

*Meubles sous-vasque / Wash-basin base units / Waschtischunterschranke / Portalavabos / Тумбы под раковину*

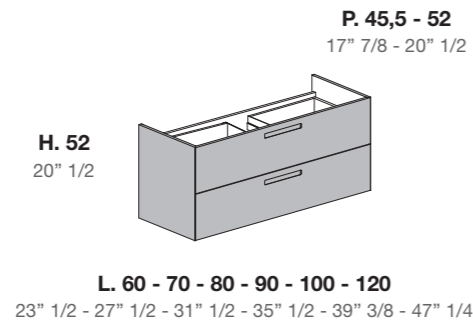
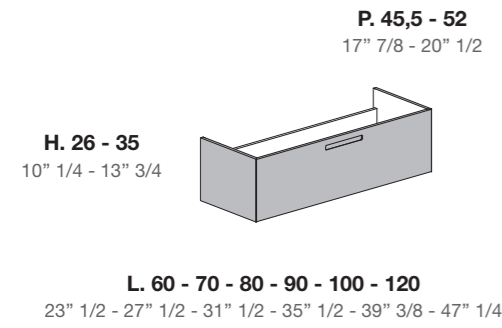

**BASI**

*Éléments bas / Base units / Unterschranke / Módulos / Тумбы*

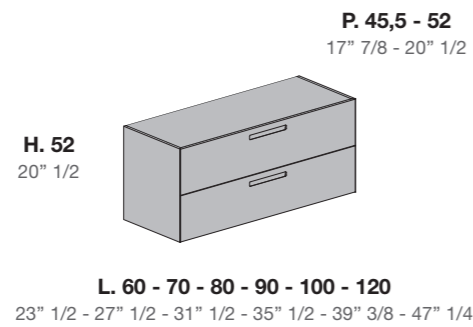
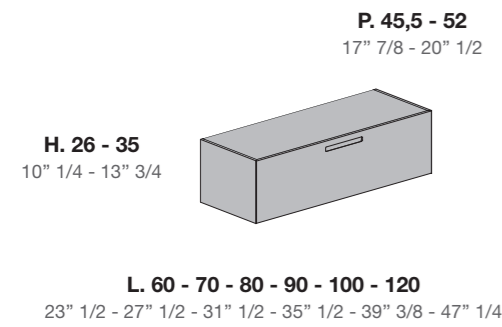

**COLORI OPACHI**

*Couleurs mates / Matt colours / Matte Farben / Colores Mates / Матовые цвета*

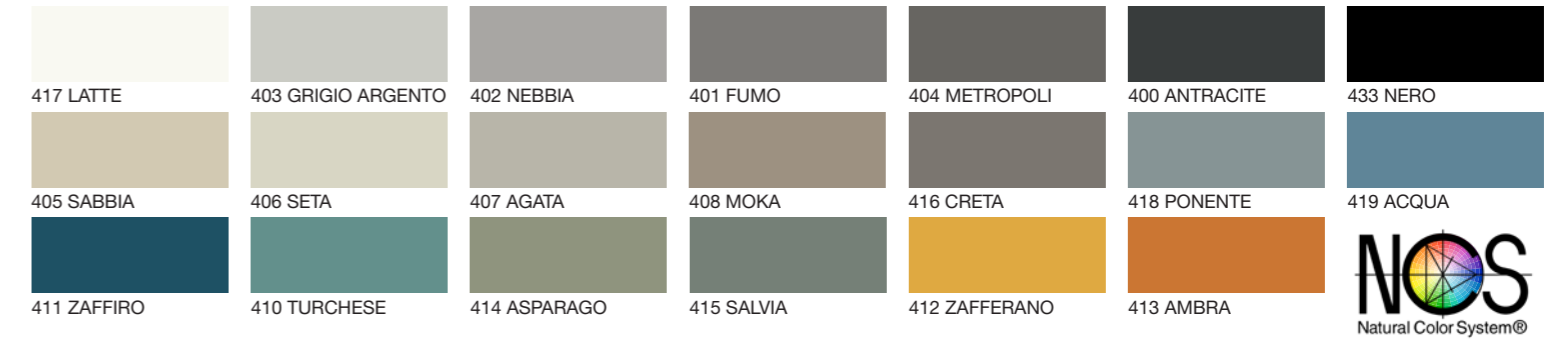

**LEGNO**

*Bois / Woods / Hölzer / Maderas / Варианты Дерева*



**METALLO**

*Métal / Metal / Metal / Metal / Металл*

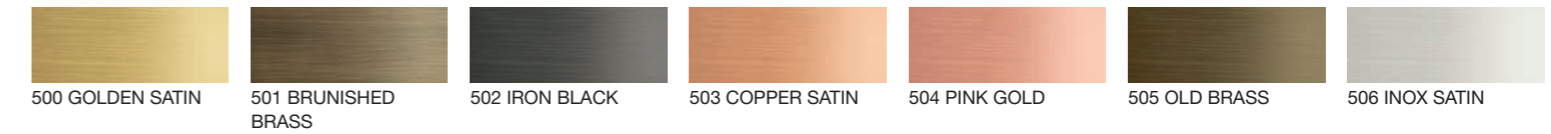



## ■ EXTREME

**IT.** Un programma definitivo ed esteticamente geometrico dove si riporta in primo piano il concetto di materia.

**FR.** *Un programme définitif et esthétiquement géométrique où le concept de matière devient à nouveau principal.*

**EN.** *A definitive and aesthetically geometric program where the concept of matter is brought back to the forefront.*

**DE.** *Ein definitives und ästhetisch geometrisches Programm, in dem das Konzept der Materie im Vordergrund steht.*

**ES.** *Un programa definitivo y estéticamente geométrico donde se destaca en primer plano el concepto de materia.*

**RU.** *Подробная и эстетически геометрическая идея, в которой концепция материи снова выдвигается на передний план.*

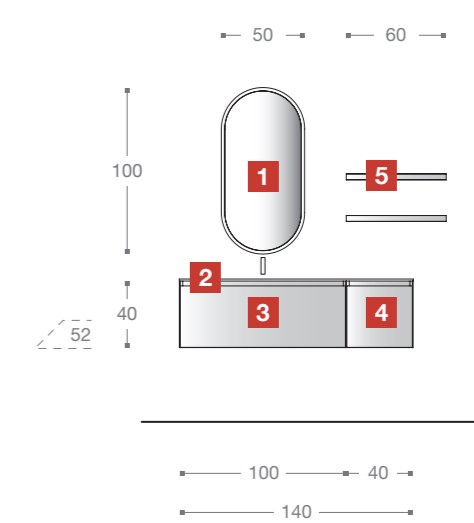

- 1** SHADE

---

- 2** **TECNOMOOD - LB857 - 408 MOKA**  
*Opaco / Mat / Matt / Matt / Mate / Матовый*

---

- 3** **TECNOLAM - 255 ROVERE PRUSSIA**

---

- 4** **TECNOLAM - 255 ROVERE PRUSSIA**

---

- 5** **SELECTA - 408 MOKA**  
*Opaco / Mat / Matt / Matt / Mate / Матовый*



**IT.** Particolare del top in Tecnomood in finitura 408 Moka opaco con vasca LB857 e cover in abbinamento.

**FR.** Détail du plan en Tecnomood en finition 408 Moka mat avec vasque moulée LB857 et cache associé.

**EN.** Detail of Tecnomood top in 408 Moka matte finish with LB857 wash-basin and matching cover.

**DE.** Detail der Tecnomood Platte in 408 Moka matt mit LB857 Waschbecken und passender Abdeckung.

**ES.** Particular de la encimera en Tecnomood en acabado 408 Moka mate con cuba LB857 y cover en combinación.

**RU.** Деталь топа из Tecnomood в матовом лаке 408 Мокка с раковиной LB857 и трапом в тон.

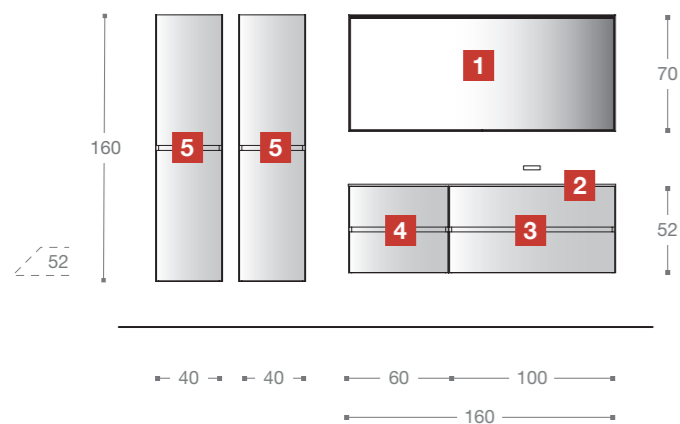

**1** BRICK - NERO  
Noir / Black / Schwarz / Negro / Черный

**2** TECNOLAM - VA014 - 251 NERO INGO

**3** TECNOLAM - 254 ROVERE SLAVONIA - 251 NERO INGO

**4** TECNOLAM - 254 ROVERE SLAVONIA - 251 NERO INGO

**5** TECNOLAM - 254 ROVERE SLAVONIA - 251 NERO INGO





**IT.** A fianco dettaglio top in Tecnomat 251 Nero Ingo e colonne con anta aperta sagomata a 45°. Nella pagina seguente una proposta della composizione con frontale in Tecnomat Nero Ingo.

**FR.** A côté détail du plan en Tecnomat 251 Nero Ingo et colonne avec porte ouverte biseauté à 45 degrés. Dans la page suivante une proposition du même ensemble avec façade en Tecnomat Nero Ingo.

**EN.** On the opposite page detail of Tecnomat Top 251 Nero Ingo and columns with open door shaped at 45°. On the next page a proposal of a composition with front in Tecnomat Nero Ingo.

**DE.** Seitlich Detail der Platte aus Tecnomat 251 Nero Ingo und Hochschränke mit offener Tür in 45°-Form. Auf der folgenden Seite ein Vorschlag für eine Komposition mit einer Front aus Tecnomat Nero Ingo.

**ES.** Al lado detalle de la encimera en Tecnomat 251 Nero Ingo y columnas con puerta abierta perfilada a 45°. EN la página siguiente una propuesta de la composición con frontal en Tecnomat Nero Ingo.

**RU.** Сбоку деталь топа из Tecnomat 251 Nero Ingo и колонны с открытой дверцей под углом 45°. На следующей странице предложена композиция с фасадом из Tecnomat Nero Ingo.



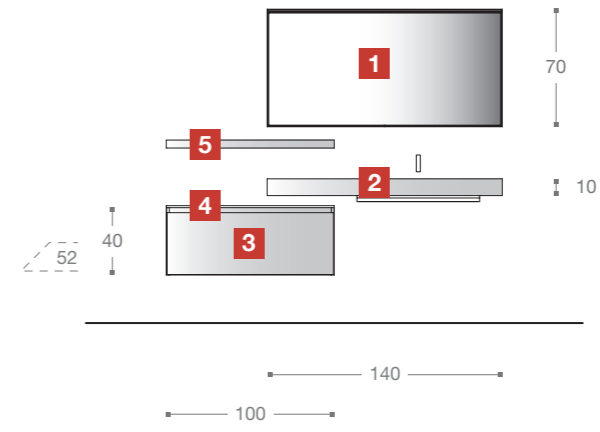

- 1** BRICK - NERO  
*Noir / Black / Schwarz / Negro / Черный*

---

- 2** TECNOLAM - VA014 - 260 IMPERO

---

- 3** TECNOLAM - 256 NOCE SAVOIA

---

- 4** TECNOLAM - 260 IMPERO

---

- 5** SELECTA - 433 NERO  
*Opaco / Mat / Matt / Matt / Mate / Матовый*







251 NERO INGO



250 BIANCO KOS



252 GRIGIO LONDON



263 SILVER VOYAGE



254 ROVERE SLAVONIA



260 IMPERO



259 CALACATTA



264 ROVERE TEXAS



256 NOCE SAVOIA



262 KASPIO ARGENTO

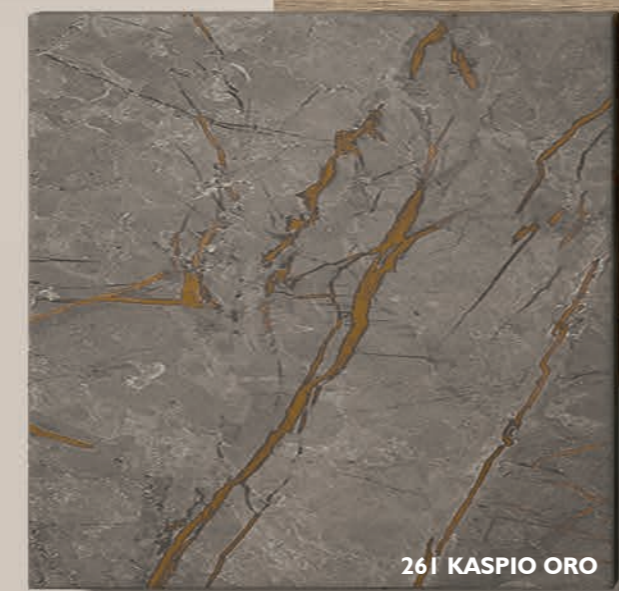

261 KASPIO ORO



255 ROVERE PRUSSIA



253 GRIGIO BROMO



257 RIVEL

V1

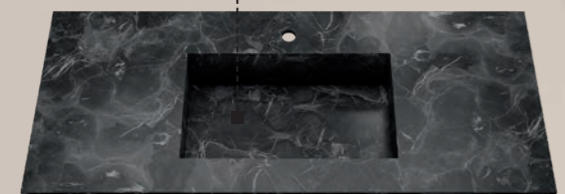

V2



04 EXTREME

- 1** KENDO

---

- 2** TECNOLAM - VA024 - 253 GRIGIO BROMO

---

- 3** TECNOLAM - 253 GRIGIO BROMO

---

- 4** TECNOLAM - 253 GRIGIO BROMO

---

- 5** TECNOLAM - 253 GRIGIO BROMO

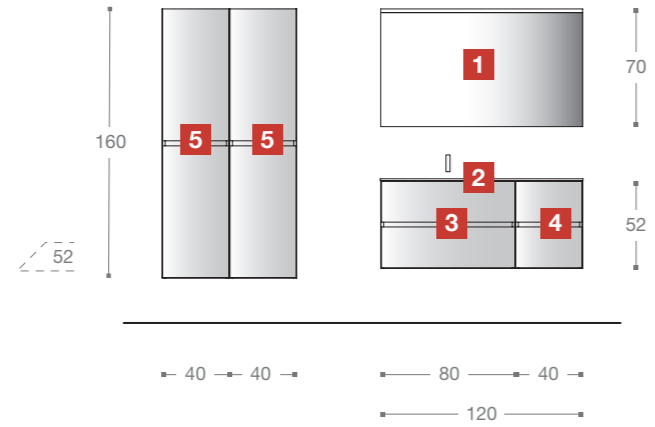

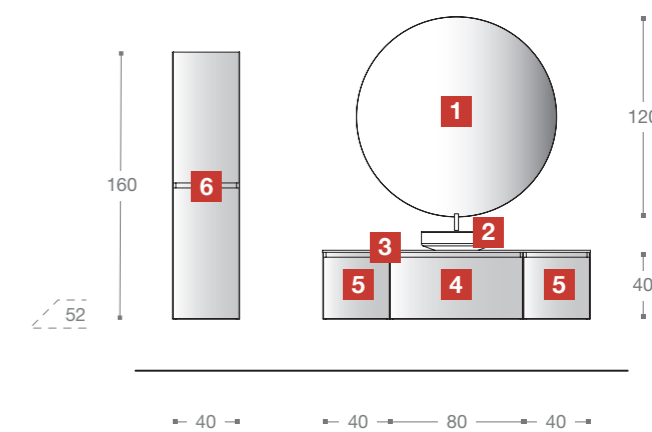

- 1** ERGO

---

- 2** IRIS - TECNOMAT

---

- 3** TECNOLAM - 255 ROVERE PRUSSIA

---

- 4** TECNOLAM - 255 ROVERE PRUSSIA -  
250 BIANCO KOS

---

- 5** TECNOLAM - 255 ROVERE PRUSSIA -  
250 BIANCO KOS

---

- 6** TECNOLAM - 255 ROVERE PRUSSIA -  
250 BIANCO KOS



**IT.** Portalavabo e base in Tecnomat 255 Rovere Prussia, con ante in Tecnomat 250 Bianco Kos; top in Tecnomat 255 Rovere Prussia con lavabo sopra piano Iris. Specchio Ergo retroilluminato luce led; colonne in Tecnomat 255 Rovere Prussia, con ante in Tecnomat 250 Bianco Kos.

**FR.** Meuble Sous-vasque et élément bas en Tecnomat 255 Rovere Prussia, avec façade en Tecnomat 250 Bianco Kos; Plan en Tecnomat 255 Rovere Prussia avec vasque à poser Iris. Miroir Ergo rétroéclairé avec lumières Led. Colonnes en tecnomat 255 Rovere Prussia, avec façades en Tecnomat 250 Bianco Kos.

**EN.** Washbasin unit and base unit in Tecnomat 255 Rovere Prussia, with doors in Tecnomat 250 Bianco Kos; Top in Tecnomat 255 Rovere Prussia with Iris countertop basin. Ergo backlit led light mirror; columns in Tecnomat 255 Rovere Prussia, with doors in Tecnomat 250 Bianco Kos.

**DE.** Waschtischunterschrank und Unterschrank in Tecnomat 255 Rovere Prussia, mit Türen in Tecnomat 250 Kos Bianco; Platte in Tecnomat 255 Rovere Prussia mit Iris Aufsatzwaschbecken. Ergo-Spiegel mit LED-Hintergrundbeleuchtung; Hochschränke in Tecnomat 255 Rovere Prussia, mit Türen in Tecnomat 250 Kos Bianco.

**ES.** Portalavabo y módulo en Tecnomat 255 Rovere Prussia, con puertas en Tecnomat 250 Bianco Kos; encimera en Tecnomat 255 Rovere Prussia con lavabo sobrecimera Iris. Espejo Ergo retroiluminado luz led; columnas en Tecnomat 255 Rovere Prussia, con puertas en Tecnomat 250 Bianco Kos.

**RU.** Тумба под раковину и тумба из Tecnomat 255 Rovere Prussia с дверцами из Tecnomat 250 Bianco Kos; топ из Tecnomat 255 Rovere Prussia с накладной раковиной Iris. Зеркало Ergo со светодиодной подсветкой; колонны из Tecnomat 255 Rovere Prussia с дверцами из Tecnomat 250 Bianco Kos.

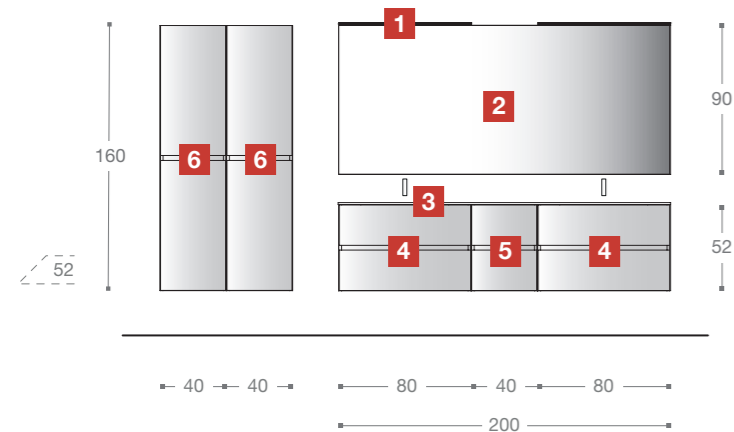

- 1** SLIM - H58.800

---

- 2** SPECCHIO FILO LUCIDO  
*Miroir simple / Simple mirror / Spiegel / Espejo  
santo pulido / Зеркало с полированными краями*

---

- 3** TECNOLAM - VA024 - 261 KASPIO ORO

---

- 4** TECNOLAM - 256 NOCE SAVOIA

---

- 5** TECNOLAM - 256 NOCE SAVOIA

---

- 6** TECNOLAM - 256 NOCE SAVOIA





**IT.** Top in Tecnomat H.1,2 cm con doppia vasca integrata, in finitura 261 Kaspio Oro.

**FR.** Plan en Tecnomat H1,2 cm avec 2 vasques moulées, en finition 261 Kaspio Oro.

**EN.** Tecnomat Top H.1.2 cm with double integrated basin, in 261 Kaspio Oro finish.

**DE.** Platte aus Tecnomat H.1,2 cm mit integriertem Doppelwaschbecken, in der Ausführung 261 Kaspio Oro.

**ES.** Encimera en Tecnomat H.1,2 cm con doble cuba integrada, en acabado 261 Kaspio Oro.

**RU.** Топ из Tecnomat выс.1,2 см с 2 интегрированными мойками в отделке 261 Kaspio Oro.

**IT.** Particolare portalavabo in Tecnomat, finitura 256 Noce Savoia, con cassetto aperto e frontale sagomato a 45°.

**FR.** Détail du meuble sous-vasque en tecnomat, finition 256 Noce Savoia, avec tiroir ouvert et façade biseauté à 45 degrés.

**EN.** Detail of Tecnomat wash-basin unit, 256 Noce Savoia finish, with open drawer and 45° shaped front.

**DE.** Detail Waschtischunterschrank aus Tecnomat, Ausführung 256 Noce Savoia, mit offener Schublade und 45° geformter Front.

**ES.** Particular portalavabo en tecnomat, acabado 256 Noce Savoia, con cajón abierto y frontal perfilado a 45°.

**RU.** Деталь тумбы под раковину из Tecnomat в отделке 256 Noce Savoia с открытым ящиком и фасадом под углом 45°.

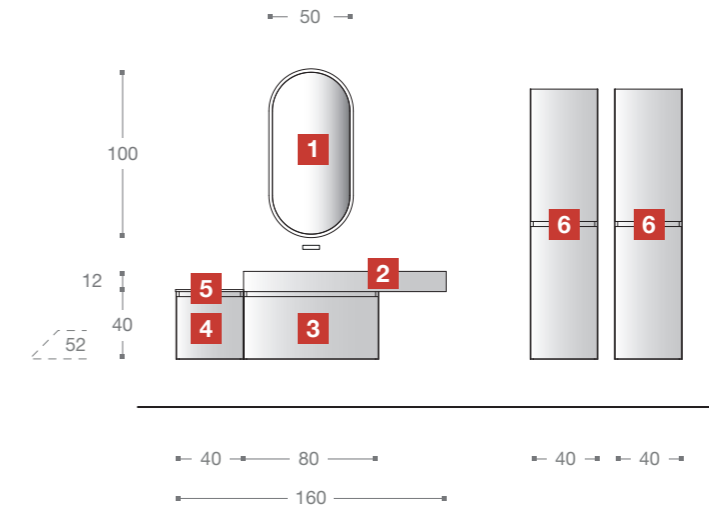

- 1** SHADE

---

- 2** TECNOGRES - LV890 - 323 PIETRA GREY

---

- 3** TECNOLAM - 252 GRIGIO LONDON

---

- 4** TECNOLAM - 252 GRIGIO LONDON

---

- 5** TECNOLAM - 252 GRIGIO LONDON

---

- 6** TECNOLAM - 252 GRIGIO LONDON



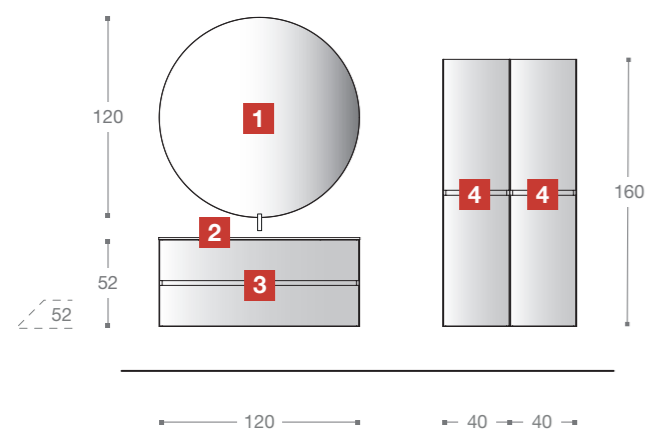

- 1** ERGO
- 2** TECNOLAM - VA025 - 251 NERO INGO
- 3** TECNOLAM - 257 RIVEL - 251 NERO INGO
- 4** TECNOLAM - 257 RIVEL - 251 NERO INGO





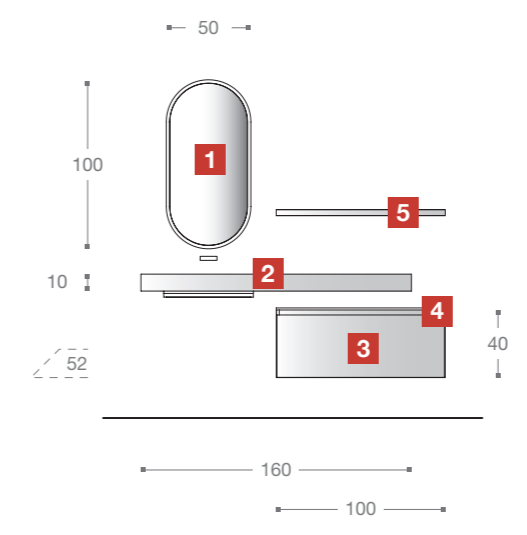

- 1** SHADE

---

- 2** TECNOLAM - VA024 - 264 ROVERE TEXAS

---

- 3** TECNOLAM - 252 GRIGIO LONDON

---

- 4** TECNOLAM - 252 GRIGIO LONDON

---

- 5** SELECTA - 416 CRETA  
*Opaco / Mat / Matt / Matt / Mate / Матовый*

**PORTALAVABI**

*Meubles sous-vasque / Wash-basin base units / Waschtischunterschranke / Portalavabos / Тумбы под раковину*

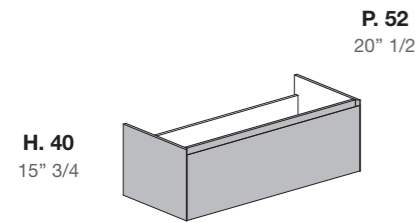

**L. 60 - 80 - 100 - 120**  
23" 1/2 - 31" 1/2 - 39" 3/8 - 47" 1/4

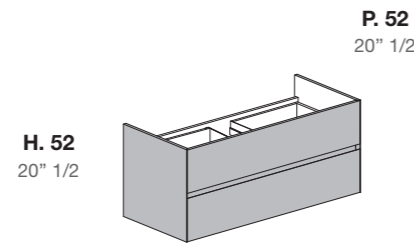

**L. 60 - 80 - 100 - 120**  
23" 1/2 - 31" 1/2 - 39" 3/8 - 47" 1/4

**BASI**

*Éléments bas / Base units / Unterschranke / Módulos / Тумбы*

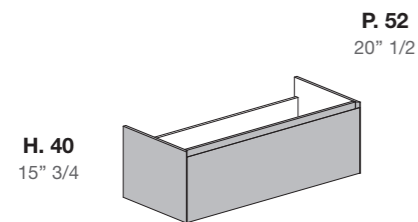

**L. 40 - 60 - 80 - 100 - 120**  
15" 3/4 - 23" 1/2 - 31" 1/2 - 39" 3/8 - 47" 1/4

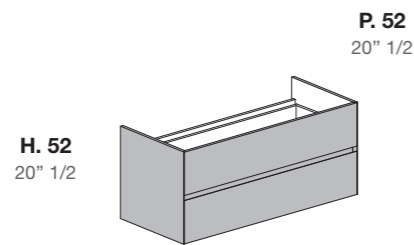

**L. 40 - 60 - 80 - 100 - 120**  
15" 3/4 - 23" 1/2 - 31" 1/2 - 39" 3/8 - 47" 1/4

**TECNOLAM - COLORI FENIX**

*Tecnolam - Couleurs / Tecnolam - Colours / Tecnolam - Farben / Tecnolam - Cores / Tecnolam - Цвета*

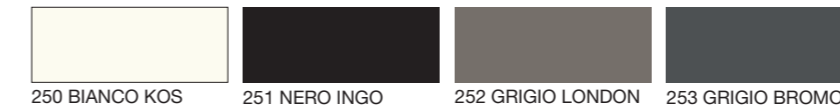

**TECNOLAM - FINITURE HPL**

*Tecnolam - Finitions HPL / Tecnolam - HPL Finishes / Tecnolam - HPL Ausführungen / Tecnolam - Acabados HPL / Tecnolam - Отделки HPL*





## ■ WILD

**IT.** Dinamicità e carattere sono i segni distintivi di Wild.

**FR.** *Dynamisme et caractère sont les signes distinctifs de la collection Wild.*

**EN.** *Dynamism and character are distinguishing features of Wild collection.*

**DE.** *Dynamik und Wesensart sind die Unterscheidungsmerkmale von Wild-Serie.*

**ES.** *Dinamismo y carácter son los signos distintivos de la colección Wild.*

**RU.** *Динамика и характер - отличительные признаки Wild.*

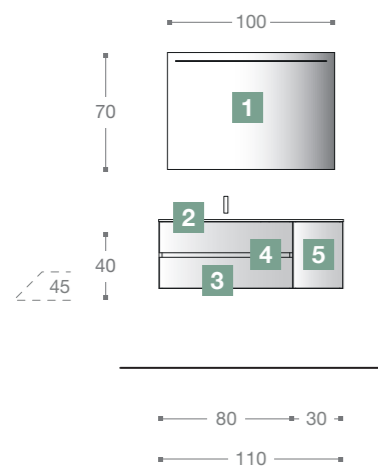

- 1** ESTRO

---

- 2** TECNOMAT - VA020

---

- 3** 935 ROVERE TITANIO

---

- 4** 413 AMBRA  
*Opaco / Mat / Matt / Mat / Mate / Матовый*

---

- 5** 935 ROVERE TITANIO  
-  
413 AMBRA  
*Opaco / Mat / Matt / Mat / Mate / Матовый*





**IT.** A sinistra particolare top in Tecnomat bianco opaco con vasca integrata L50 cm. Sopra base con anta laccata opaco 413 Ambra e scocca in essenza 935 Rovere Titanio.

**FR.** A gauche: détail plan en Tecnomat blanc mat avec vasque intégrée L. 50 cm. En haut: élément avec porte laquée 413 Ambra mat et caisson en finition bois 935 Rovere Titanio.

**EN.** Left: Detail of matt white Tecnomat top with integrated basin W.50 cm. Above base unit with matt lacquered door 413 Ambra and cabinet in 935 Rovere Titanio wood finish.

**DE.** Links: Detail des Tops in mattweißem Tecnomat mit integriertem Becken B.50 cm. Oben unterschrank mit 413 Ambra matt lackierter Tür und Korpus auf 935 Rovere Titanio Holzoptik.

**ES.** A la izquierda: detalle encimera en Tecnomat blanco mate con lavabo integrado A.50 cm. Debajo módulo con puerta lacado 413 Ambra mate y carcasa en 935 Rovere Titanio.

**RU.** Слева деталь топа из Техномата с интегрированной мойкой длиной 50 см. Зеркало Estro со светодиодной подсветкой. Вверху тумба с дверцей матовый цвет лака 413 Ambra и корпус в отделке под дерево 935 Rovere Titanio.

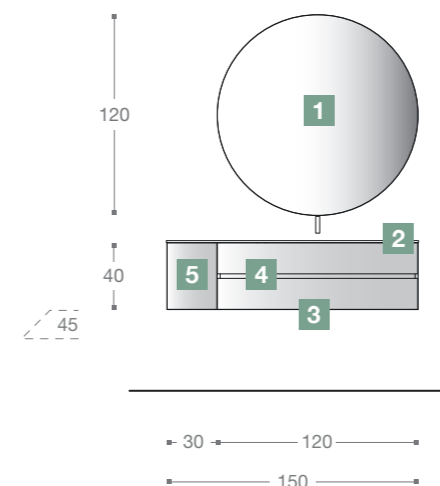

- 1 ERGO**

---

- 2 TECNOMAT - VA021**

---

- 3 937 ROVERE ELEGANCE**

---

- 4 410 TURCHESE**  
*Opaco / Mat / Matt / Matt / Mate / Матовый*

---

- 5 937 ROVERE ELEGANCE**  
**410 TURCHESE**  
*Opaco / Mat / Matt / Matt / Mate / Матовый*



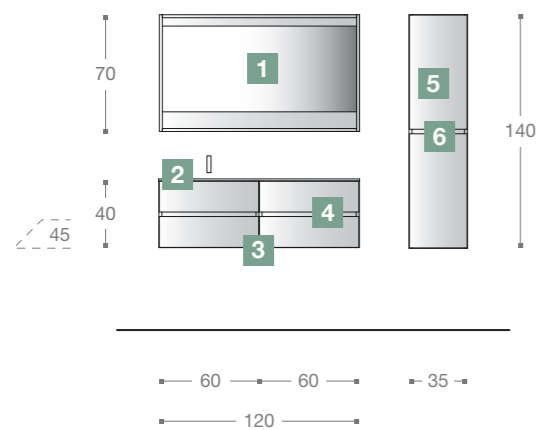

**1** UNIKO - 937 ROVERE ELEGANCE

**2** 433 NERO - VA022  
Vetro Satinato / Verre Satiné / Frosted Glass /  
Satinierter Glas / Cristal Satinado / Стекло матовое

**3** 937 ROVERE ELEGANCE

**4** 433 NERO  
Opaco / Mat / Matt / Mate / Матовый

**5** 937 ROVERE ELEGANCE

**6** 433 NERO  
Opaco / Mat / Matt / Mate / Матовый



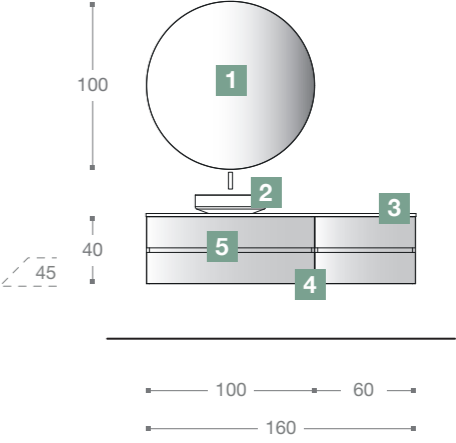

- 1 ERGO**

---

- 2 IRIS - TECNOMAT -BIANCO OPACO**  
Blanc Mat / White Matt / Weiß Matt / Blanco Mate / Белый Матовый

---

- 3 937 ROVERE ELEGANCE**

---

- 4 937 ROVERE ELEGANCE**

---

- 5 404 METROPOLI**  
Opaco / Mat / Matt / Matt / Mate / Матовый



05 WILD

- 1** SURA - NERO  
*Noir / Black / Schwarz / Negro / Черный*

---

- 2** SPECCHIO FILO LUCIDO  
*Miroir simple / Simple mirror / Spiegel / Espejo canto pulido / Зеркало с полированными краями*

---

- 3** 939 RIGATO IMPERIALE  
-  
**400 ANTRACITE**  
*Opaco / Mat / Matt / Mate / Матовый*

---

- 4** TECNOMAT - VA021

---

- 5** 939 RIGATO IMPERIALE

---

- 6** 400 ANTRACITE  
*Opaco / Mat / Matt / Mate / Матовый*

---

- 7** 939 RIGATO IMPERIALE  
-  
**400 ANTRACITE**  
*Opaco / Mat / Matt / Mate / Матовый*

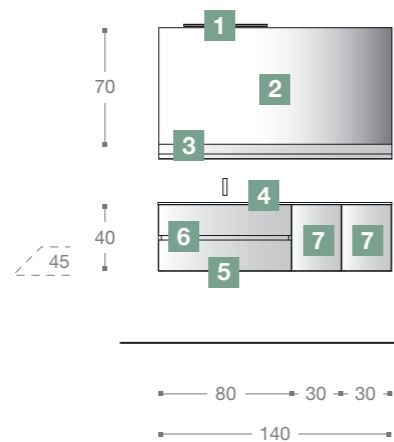

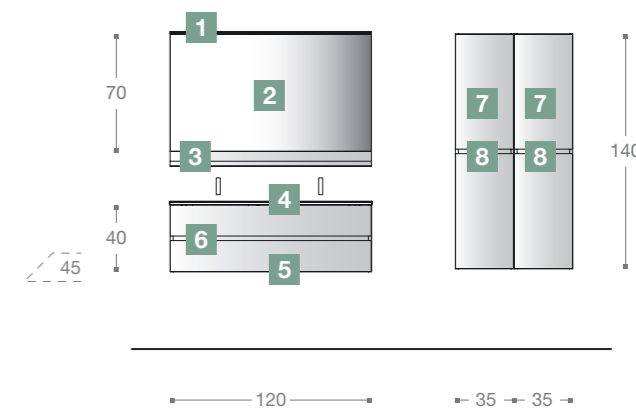

- 1** SLIM - H58.1200

---

- 2** SPECCHIO FILO LUCIDO  
*Miroir simple / Simple mirror / Spiegel / Espejo canto pulido / Зеркало с полированными краями*

---

- 3** 938 ROVERE NORDICO  
416 CRETA  
*Opaco / Mat / Matt / Mate / Матовый*

---

- 4** CERAMICA - TK067  
*Ceramique / Ceramic / Keramik / Cerámica / Керамика*

---

- 5** 938 ROVERE NORDICO

---

- 6** 416 CRETA  
*Opaco / Mat / Matt / Mate / Матовый*

---

- 7** 938 ROVERE NORDICO

---

- 8** 416 CRETA  
*Opaco / Mat / Matt / Mate / Матовый*



**IT.** Portalavabo in essenza 938 Rovere Nordico con profilo a gola laccato opaco 416 Creta. Top in ceramica con doppia vasca integrata. Specchio filo lucido con lampada Slim e mensola in metallo laccato opaco 416 Creta con inserto in essenza 938 Rovere Nordico. Colonne in essenza 938 Rovere Nordico con profilo a gola laccato opaco 416 Creta.

**FR.** Meuble sous-vasque en finition bois 938 Rovere Nordico avec rainure laquée 416 Creta mat. Plan en céramique avec double-vasque intégrée. Miroir simple avec applique Slim et étagère en métal laquée 416 Creta mat avec bandeau en finition bois 938 Rovere Nordico. Colonne en finition bois 938 Rovere Nordico avec rainure laquée 416 Creta mat.

**EN.** Washbasin unit 938 Rovere Nordico wood finish with groove profile 416 Creta matt lacquered. Ceramic top with integrated double washbasin. Mirror with Slim lamp and metal shelf 416 Creta matt lacquered with insert 938 Rovere Nordico wood finish. Tall units 938 Rovere Nordico wood finish with groove profile 416 Creta matt lacquered.

**DE.** Waschtischunterschrank 938 Rovere Nordico Holzoptik mit Rillenprofil 416 Creta matt lackiert. Keramik-waschtisch mit integriertem Doppelwaschbecken. Spiegel mit Slim-Lampe und Metall-Regal 416 Creta matt lackiert mit Einsatz 938 Rovere Nordico Holzoptik. Hochschränke 938 Rovere Nordico Holzoptik mit Rillenprofil 416 Creta matt lackiert.

**ES.** Portalavabo en acabado madera 938 Rovere Nordico con tirador a gola lacado 416 Creta mate. Encimera de cerámica con doble lavabo integrado. Espejo canto pulido con lámpara Slim y repisa de metal lacada 416 Creta mate con banda en acabado madera 938 Rovere Nordico. Columnas en acabado madera 938 Rovere Nordico con tirador a gola lacado 416 Creta mate.

**RU.** Тумба под раковину в отделке под дерево 938 Rovere Nordico с профилем Gola матовый цвет лака 416 Creta. Топ из керамики с двумя интегрированными мойками. Зеркало с полированными краями со светильником Slim в черном цвете; полка матовый цвет лака 400 Antracite со вставкой в отделке под дерево 938 Rovere Nordico с профилем Gola матовый цвет лака 416 Creta.



- 1** KENDO

---

- 2** 433 NERO - VA022  
*Vetro Satinato / Verre Satiné / Frosted Glass / Satiniert Glas / Cristal Satinado / Стекло матовое*

---

- 3** 935 ROVERE TITANIO

---

- 4** 433 NERO  
*Opaco / Mat / Matt / Mate / Матовый*

---

- 5** 935 ROVERE TITANIO

---

- 6** 433 NERO  
*Opaco / Mat / Matt / Mate / Матовый*

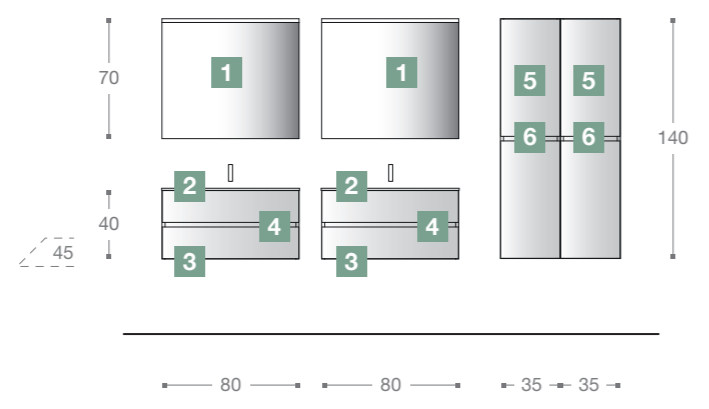

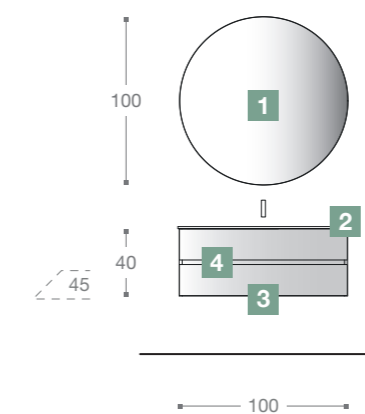

- 1 ERGO**

---

- 2 CERAMICA - TK095**  
*Ceramique / Ceramic / Keramik / Cerámica / Керамика*

---

- 3 939 RIGATO IMPERIALE**

---

- 4 411 ZAFFIRO**  
*Opaco / Mat / Matt / Matt / Mate / Матовый*



1 SLIM - H58.1000

2 SPECCHIO FILO LUCIDO  
Miroir simple / Simple mirror / Spiegel / Espejo  
canto pulido / Зеркало с полированными краями

3 937 ROVERE ELEGANCE

4 414 ASPARAGO  
Opaco / Mat / Matt / Mate / Матовый

4 TECNOMAT - VA020

5 937 ROVERE ELEGANCE

6 414 ASPARAGO  
Opaco / Mat / Matt / Mate / Матовый

937 ROVERE ELEGANCE

7 414 ASPARAGO  
Opaco / Mat / Matt / Mate / Матовый

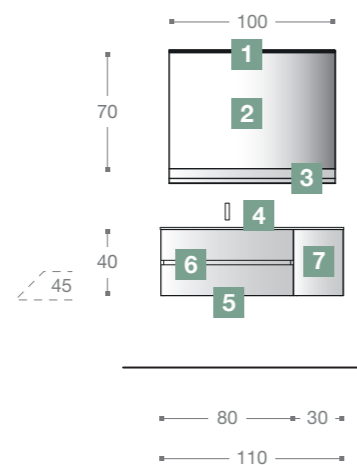

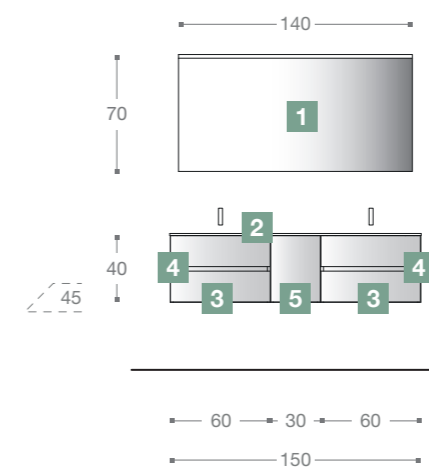

- 1 KENDO**

---

- 2 TECNOMAT - VA020**

---

- 3 939 RIGATO IMPERIALE**

---

- 4 418 PONENTE**  
*Opaco / Mat / Matt / Matt / Mate / Матовый*

---

- 5 939 RIGATO IMPERIALE**  
**418 PONENTE**  
*Opaco / Mat / Matt / Matt / Mate / Матовый*



**PORTALAVABI**

*Meubles sous-vasque / Wash-basin base units / Waschtischunterschranke / Portalavabos / Тумбы под раковину*

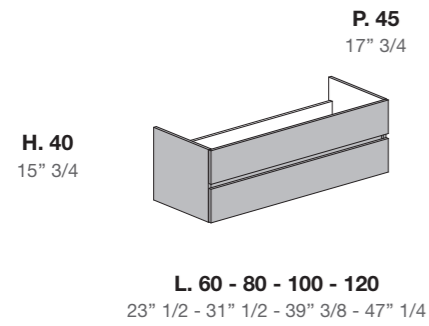

**BASI**

*Éléments bas / Base units / Unterschranke / Módulos / Тумбы*

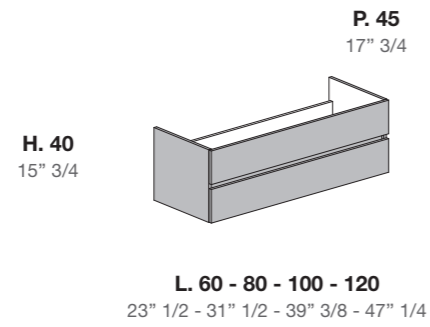
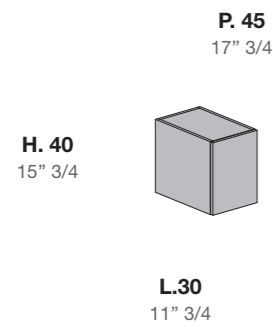

**COLORI OPACHI**

*Couleurs mates / Matt colours / Matte Farben / Colores Mates / Матовые цвета*

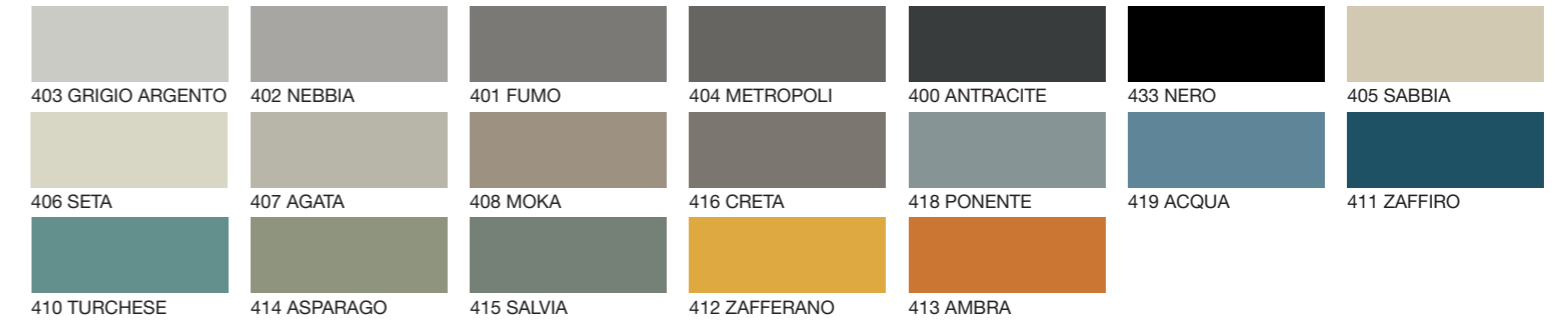

**ESSENZE**

*Finition bois / Wood finishes / Holzoptik / Acabados mader / Отделки под дерево*

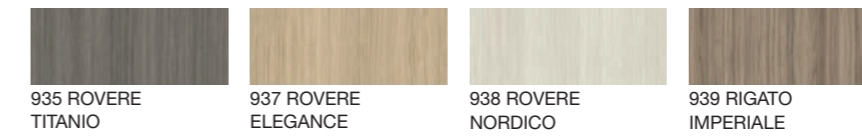

**BIANCO OPACO**

*Blanc Mat / Matt White / Weiss Matt / Blanco Mate / Белый Матовый*

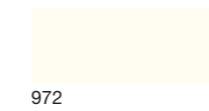





## ■ UNDERGROUND

**IT.** Un sistema d'arredo multiforme e dai tratti urban chic. Il sistema Underground offre molteplici configurazioni formali, dimensionali e cromatiche.

**FR.** Un système d'ameublement varié et urban chic. La collection Underground propose plusieurs configurations, dans les formes, dimensions et couleurs.

**EN.** A multifaceted furniture system with urban chic features. The Underground system offers multiple formal, dimensional and color configurations.

**DE.** Ein vielgestaltiges Möbelsystem mit urbanem Schick. Das Underground-System bietet mehrere formale, dimensionale und farbliche Konfigurationen.

**ES.** Un sistema de decoración multiforme y con rasgos urbanos chic. El sistema Underground ofrece múltiples configuraciones formales, dimensionales y cromáticas.

**RU.** Многогранная система мебели с чертами городского шика. Система Underground предлагает множество форм, объемных и хроматических конфигураций.

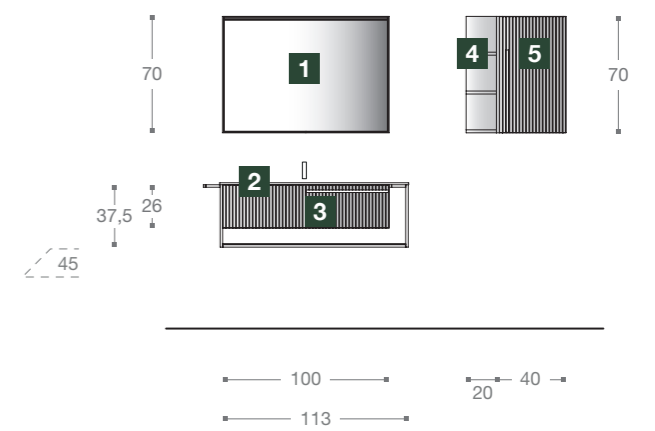

- 1** **BRICK - NERO**  
*Noir / Black / Schwarz / Negro / Черный*

---

- 2** **TECNOMAT - TK042**

---

- 3** **TEXTURE - 415 SALVIA**  
*Opaco / Mat / Matt / Mate / Матовый*

---

- 4** **415 SALVIA**  
*Opaco / Mat / Matt / Mate / Матовый*

---

- 5** **TEXTURE - 415 SALVIA**  
*Opaco / Mat / Matt / Mate / Матовый*



**IT.** Particolare del pensile a giorno con due ripiani, laccato opaco 415 Salvia e del pensile laccato opaco 415 Salvia, con anta con texture e maniglia in alluminio finitura Nero.

**FR.** Détail de l'armoire ajourée avec 2 étagères, laquée 415 Salvia mat et de l'armoire avec porte rainurée laquée 415 Salvia mat et poignée en aluminium noir.

**EN.** Detail of the open wall unit with two shelves, matte lacquered 415 Salvia, with textured door and Black finish aluminum handle.

**DE.** Detail des offenen Hängeschanks mit zwei Einlegeböden, matt lackiert 415 Salvia, mit Tür in Texture Ausführung und schwarzem Aluminiumgriff.

**ES.** Particular del armario abierto con dos repisas, lacado mate 415 Salvia y del armario lacado mate 415 Salvia, con puerta con texturas y tiradores en aluminio acabado Negro.

**RU.** Деталь открытого шкафчика с двумя полками в матовом лаке 415 Salvia и шкафчик в матовом лаке 415 Salvia с фрезерованным фасадом и ручкой из алюминия цвет Negro.

**IT.** Dettaglio della lavorazione tridimensionale effettuata sul frontale del portalavabo laccato opaco 415 Salvia, sostenuto da una struttura di profili in alluminio e da un piano d'appoggio in finitura Fumè.

**FR.** Détail de la fabrication tridimensionnelle réalisée sur la façade du meuble sous-vasque laquée 415 Salvia mat, entouré par la structure en aluminium anodisé noir et d'une étagère en plexi fumé.

**EN.** Detail of the three-dimensional crafting done on the front of the 415 Salvia matte lacquered wash-basin unit, supported by a structure of aluminum profiles and a countertop in Fumè finish.

**DE.** Detail der dreidimensionalen Bearbeitung der Vorderseite des matt lackierten Waschtischunterschrankes 415 Salvia, der von einer Struktur aus Aluminiumprofilen und einer Ablage in Fumè-Finish getragen wird.

**ES.** Detalle del tratamiento tridimensional efectuado en el frontal del portalavabo lacado mate 415 Salvia, sostenido por una estructura de perfiles en aluminio y de un plano de apoyo en acabado Ahumado.

**RU.** Деталь рельефной 3D обработки, выполненной на фасадной части тумбы под раковину в матовом лаке 415 Salvia, поддерживаемой конструкцией из алюминиевых профилей и полкой в отделке Fumè.

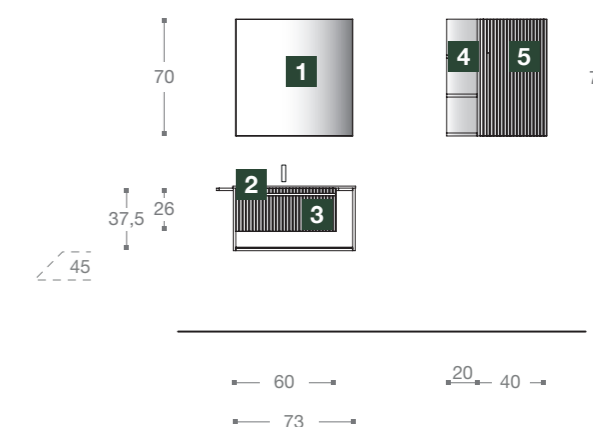

- 1** EDEN

---

- 2** TECNOMAT - TK038

---

- 3** TEXTURE - 415 SALVIA  
*Opaco / Mat / Matt / Mate / Матовый*

---

- 4** 415 SALVIA  
*Opaco / Mat / Matt / Mate / Матовый*

---

- 5** TEXTURE - 415 SALVIA  
*Opaco / Mat / Matt / Mate / Матовый*

03 UNDERGROUND

1 UNIKO - 935 ROVERE TITANIO

2 TECNOMAT - TK035

3 935 ROVERE TITANIO

4 935 ROVERE TITANIO

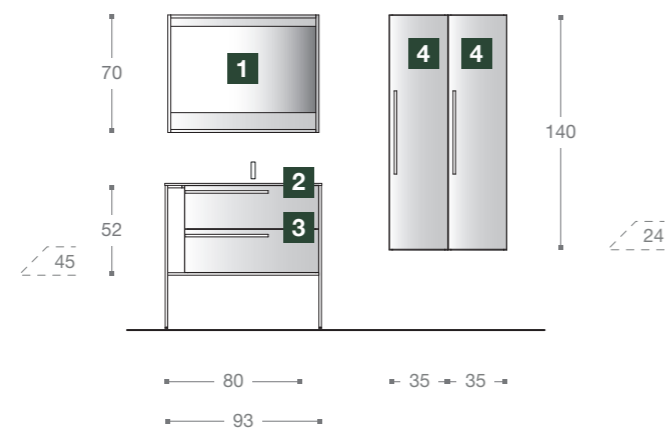

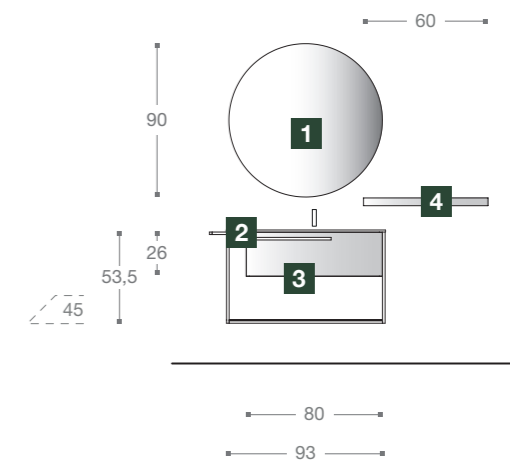

- 1** ERGO

---

- 2** TECNOMAT - TK035

---

- 3** NCS: S 6010-G50Y  
*Opaco / Mat / Matt / Matt / Mate / Матовый*

---

- 4** SELECTA - 433 NERO  
*Opaco / Mat / Matt / Matt / Mate / Матовый*

## SPECCHIO FILO LUCIDO H70

Miroir Simple H70 / Simple Mirror H70 / Spiegel H70 / Espejo Canto Pulido H70 / Зеркало С Полированными Краями Выс. 70

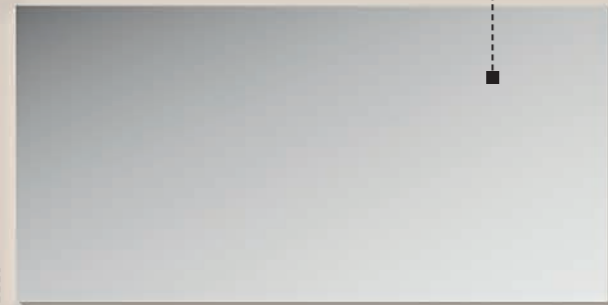

## DRUM

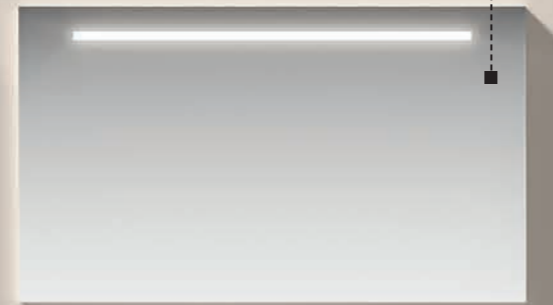

## SPECCHIO FILO LUCIDO H90

Miroir Simple H90 / Simple Mirror H90 / Spiegel H90 / Espejo Canto Pulido H90 / Зеркало С Полированными Краями Выс. 90

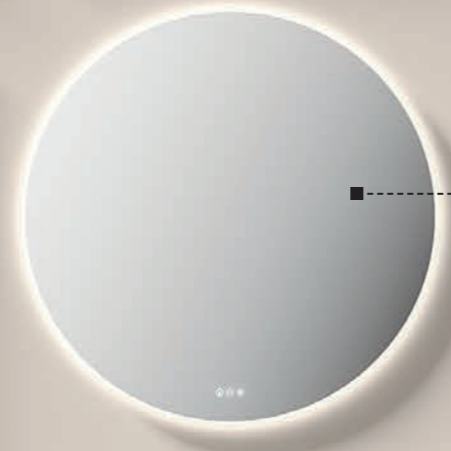

## ALFA

## ESTRO

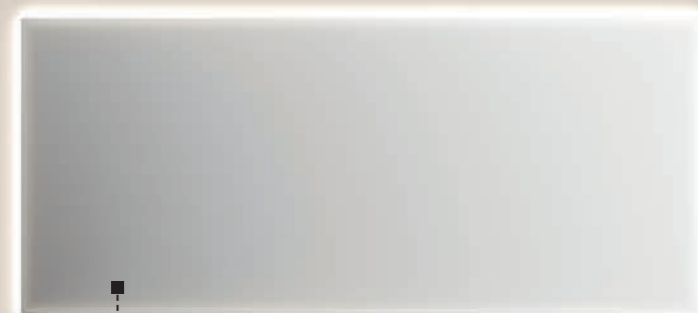
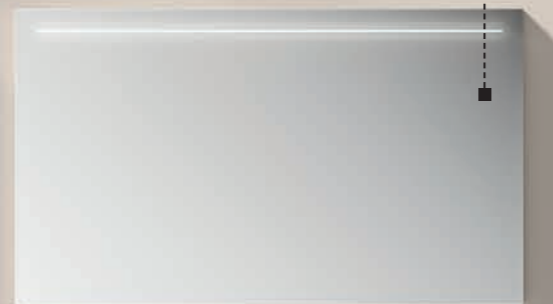

## EDEN



## NOBI

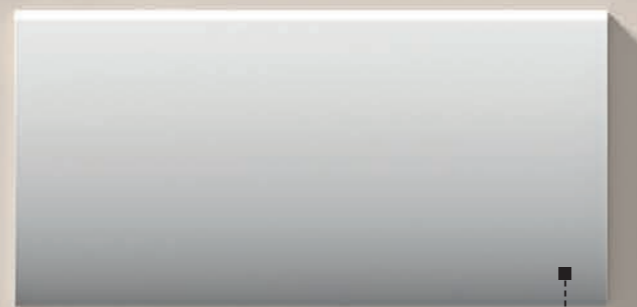

## KENDO

## SHADE



## RENE



## SPECCHIO CON CORNICE IN LEGNO

Miroir avec contour en bois / Mirror with wood frame / Spiegel mit Holzrahmen / Espejo con marco de madera / Зеркало с деревянной рамкой

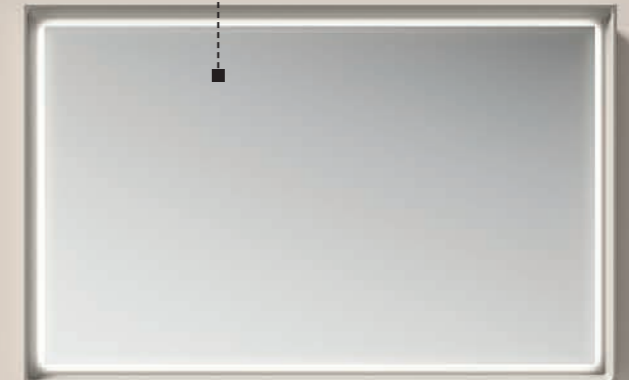

## DOT

## GENESIS



## BRICK



## UNIKO

## SPECCHIO CONTENITORE

Armoire Miroir / Mirror Cabinet / Spiegelschrank / Armario Espejo / Зеркальный Шкаф



## ERGO

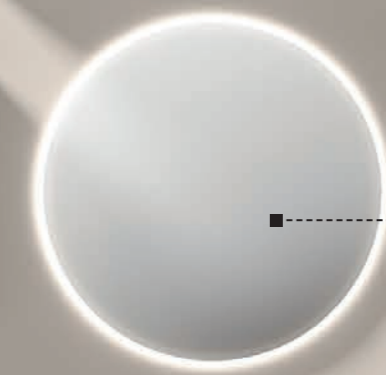



- 1** KENDO

---

- 2** TECNOMAT - TK042

---

- 3** 934 NOCE BROWN

---

- 4** 934 NOCE BROWN

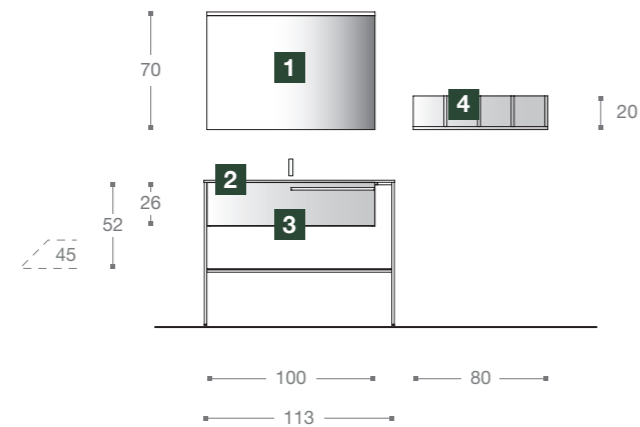



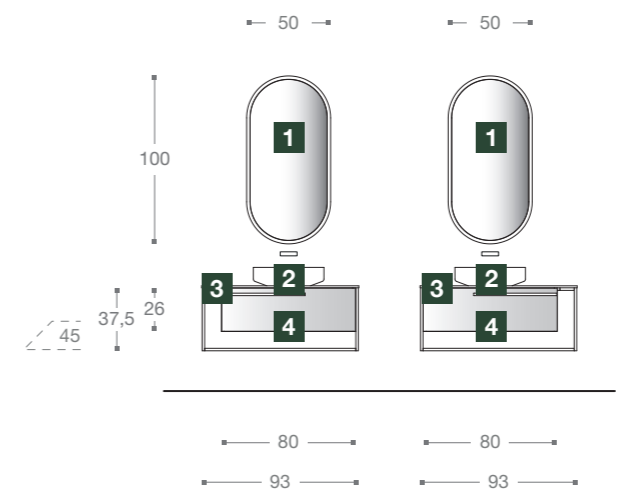

- 1** SHADE

---

- 2** IRIS - TECNOMAT - 418 PONENTE  
*Opaco / Mat / Matt / Mate / Матовый*

---

- 3** TECNOMOOD - 418 PONENTE  
*Opaco / Mat / Matt / Mate / Матовый*

---

- 4** 418 PONENTE  
*Opaco / Mat / Matt / Mate / Матовый*



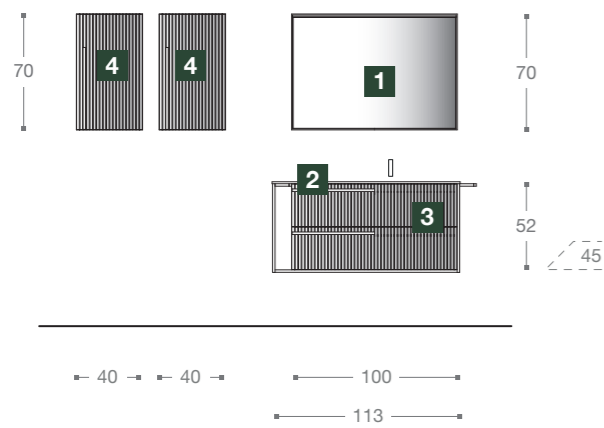

- 1** **BRICK - NERO**  
*Noir / Black / Schwarz / Negro / Черный*

---

- 2** **TECNOMAT - TK037**

---

- 3** **TEXTURE - 407 AGATA**  
*Opaco / Mat / Matt / Mate / Матовый*

---

- 4** **TEXTURE - 407 AGATA**  
*Opaco / Mat / Matt / Mate / Матовый*





**IT.** Pensili laccati opaco 407 Agata con lavorazione tridimensionale sull'anta e maniglia in finitura Nero.

**FR.** Armoires laquées mat 407 Agata avec rainures sur la façade et poignée noire.

**EN.** Matt lacquered 407 Agata wall units with three-dimensional crafting on the door and handle in Black finish.

**DE.** Matt lackierte 407 Agata Hängeschränke mit dreidimensionaler Verarbeitung an Tür und Griff in Schwarz.

**ES.** Armarios lacados mate 407 Agata con labor tridimensional en la puerta y tirador en acabado Negro.

**RU.** Шкафчики в матовом цвете Agata 407 с рельефной 3D обработкой дверцы и ручкой в цвете Nero.



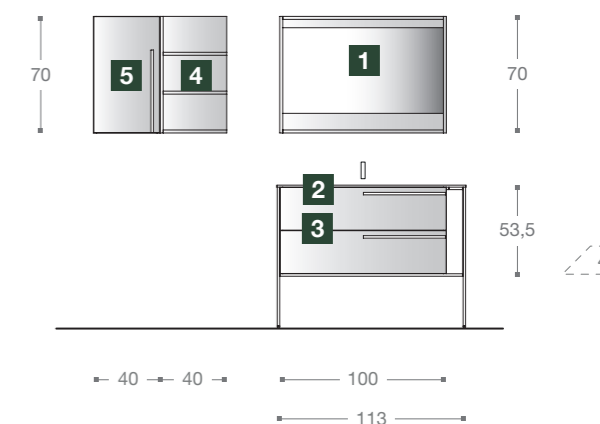

**1** UNIKO - 937 ROVERE ELEGANCE

**2** TECNOMAT - TK042

**3** 937 ROVERE ELEGANCE

**4** 408 MOKA  
Opaco / Mat / Matt / Matte / Матовый

**5** 937 ROVERE ELEGANCE

### MONOBLOCCHI

Meubles sous-vasque / Wash-basin units / Waschtischunterschranke / Monobloques / Моноблоки

H. 37,5  
14" 3/4

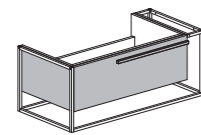

P. 45  
17" 3/4

L. 73 - 93 - 113  
28" 3/4 - 36" 5/8 - 44" 1/2

H. 53,5  
21" 1/8

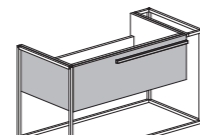

P. 45  
17" 3/4

L. 73 - 93 - 113  
28" 3/4 - 36" 5/8 - 44" 1/2

H. 53,5  
21" 1/8

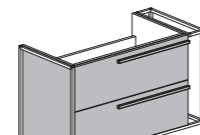

P. 45  
17" 3/4

L. 73 - 93 - 113  
28" 3/4 - 36" 5/8 - 44" 1/2

H. 85  
33" 1/2

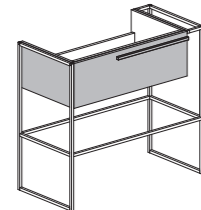

P. 45  
17" 3/4

L. 73 - 93 - 113  
28" 3/4 - 36" 5/8 - 44" 1/2

H. 85  
33" 1/2

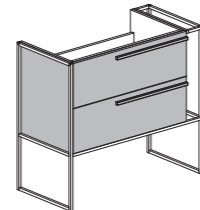

P. 45  
17" 3/4

L. 73 - 93 - 113  
28" 3/4 - 36" 5/8 - 44" 1/2

### COLORI OPACHI

Couleurs mates / Matt colours / Matte Farben / Colores Mates / Матовые цвета

417 LATTE	403 GRIGIO ARGENTO	402 NEBBIA	401 FUMO	404 METROPOLI	400 ANTRACITE	433 NERO
405 SABBIA	406 SETA	407 AGATA	408 MOKA	416 CRETA	418 PONENTE	419 ACQUA
411 ZAFFIRO	410 TURCHESE	414 ASPARAGO	415 SALVIA	412 ZAFFERANO	413 AMBRA	NOS Natural Color System®

### ESSENZE

Finition bois / Wood finishes / Holzoptik / Acabados maderá / Отделки под дерево

936 ROVERE CLASSIC	937 ROVERE ELEGANCE	938 ROVERE NORDICO	935 ROVERE TITANIO	939 RIGATO IMPERIALE	934 NOCE BROWN	967 ROVERE CAFFÈ
948 VINTAGE AVANA	960 NATIVO NATURALE	961 NATIVO COTTO	944 PRIMITIVO NATURALE	945 PRIMITIVO GRIGIO		



## ■ MOON

- IT.** Un programma che propone infinite soluzioni, dimensionali, cromatiche e di finiture. Moon offre molteplici soluzioni di apertura, in grado di soddisfare qualsiasi esigenza.
- FR.** *Un programme qui propose des solutions infinies de dimension, couleur et finitions. Moon vous offre plusieurs possibilités d'ouverture, capables de satisfaire toutes vos exigences.*
- EN.** *A program that offers endless solutions in terms of dimensions, colors and finishes. Moon offers several opening solutions for any requirement.*
- DE.** *Ein Programm, das unendlich viele Lösungen in Bezug auf Abmessungen, Farben und Ausführungen bietet. Moon bietet mehrere Öffnungslösungen für jede Anforderung.*
- ES.** *Un programa que propone infinitas soluciones, dimensionales, cromáticas y de acabados. Moon ofrece múltiples soluciones de apertura, capaces de satisfacer cualquier necesidad.*
- RU.** *Программа, предлагающая бесконечные размерные, хроматические и отделочные решения. Moon предлагает множество решений открытия, способных удовлетворить любые потребности.*

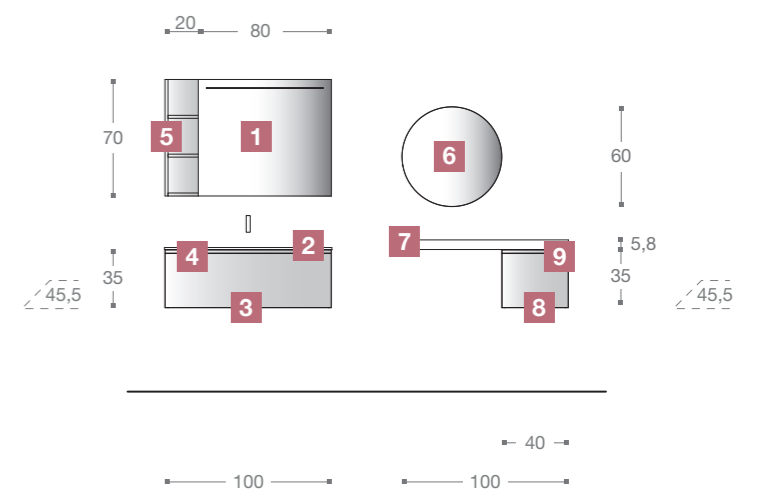

- 1 ESTRO**

---

- 2 TECNOMOOD - LB452 - 404 METROPOLI**  
*Opaco / Mat / Matt / Matt / Mate / Матовый*

---

- 3 404 METROPOLI**  
*Opaco / Mat / Matt / Matt / Mate / Матовый*

---

- 4 PRESA MANIGLIA**  
*Prise De Main / Integrated Pull / Geprüft / Griffmulde / Tirador Integrado / Фрезер. ручка*

---

- 5 404 METROPOLI**  
*Opaco / Mat / Matt / Matt / Mate / Матовый*

---

- 6 ERGO**

---

- 7 404 METROPOLI**  
*Opaco / Mat / Matt / Matt / Mate / Матовый*

---

- 8 404 METROPOLI**  
*Opaco / Mat / Matt / Matt / Mate / Матовый*

---

- 9 PRESA MANIGLIA**  
*Prise De Main / Integrated Pull / Geprüft / Griffmulde / Tirador Integrado / Фрезер. ручка*

**IT.** A fianco particolare del complemento composizione con specchio Ergo retroilluminato luce Led, e top H.5,8 L.100 P.37,5 cm con base L.40 cm laccato opaco 404 Metropoli. Nella pagina seguente dettaglio top in Tecnomood con vasca integrata in finitura 404 Metropoli opaco.

**FR.** A côté le détail du miroir Ergo à éclairage led et plan H.5,8 L.100 P.37,5 avec élément L.40 laqué mat 404 Metropoli. Dans la page suivante détail du plan en Tecnomood avec vasque moulée en finition 404 Metropoli mat.

**EN.** On the opposite page detail of the complement of the composition with Ergo mirror backlit Led light, and top H.5.8 W.100 D.37.5 cm with base L.40 cm lacquered matt 404 Metropoli. On the next page detail of Tecnomood top with integrated basin in 404 Metropoli matte finish.

**DE.** Auf der gegenüberliegenden Seite Detail der Komposition mit Ergo-Spiegel mit Led-Hintergrundbeleuchtung und Platte H.5,8 B.100 T.37,5 cm mit Unterschrank L.40 cm matt lackiert 404 Metropoli. Auf der folgenden Seite Detail der Tecnomood Platte mit integriertem Waschbecken in der Ausführung matt 404 Metropoli.

**ES.** Al lado particular del complemento de la composición con espejo Ergo retroiluminado luz led, y encimera H.5,8 A.100 P.37,5 cm con módulo A.40 cm lacado mate 404 Metropoli. En la página siguiente detalle encimera en Tecnomood con cuba integrada en acabado 404 Metropoli mate.

**RU.** Рядом дополнительная деталь композиции с зеркалом Ergo со светодиодной подсветкой и топ выс.5,8 шир.100 гл.37,5 см с тумбой шир.40 см в матовом лаке 404 Metropoli. На следующей странице деталь топа Tecnomood со встроенной раковиной в матовом лаке 404 Metropoli.





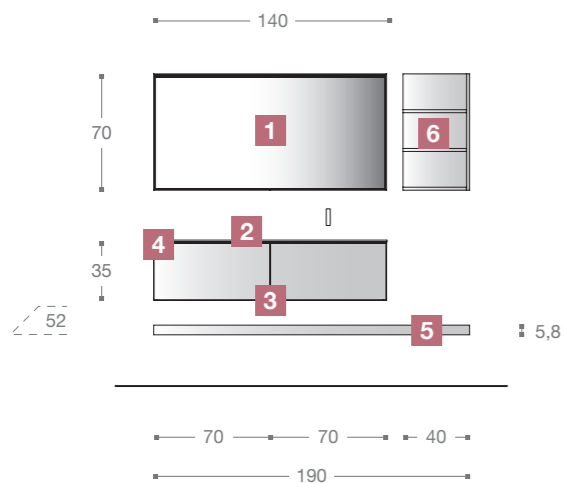

- 1** **BRICK - 415 SALVIA**  
Opaco / Mat / Matt / Matt / Mate / Матовый
- 2** **TECNOMOOD - LB856 - 415 SALVIA**  
Opaco / Mat / Matt / Matt / Mate / Матовый
- 3** **415 SALVIA**  
Opaco / Mat / Matt / Matt / Mate / Матовый
- 4** **G56 - 415 SALVIA**  
Opaco / Mat / Matt / Matt / Mate / Матовый
- 5** **415 SALVIA**  
Opaco / Mat / Matt / Matt / Mate / Матовый
- 6** **415 SALVIA**  
Opaco / Mat / Matt / Matt / Mate / Матовый



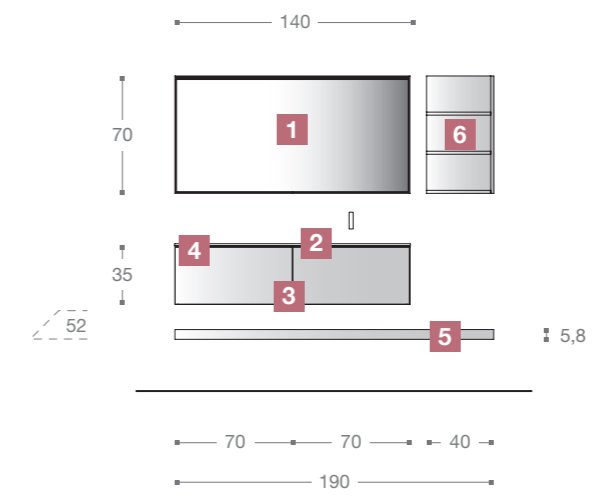

- 1** BRICK - 407 AGATA  
*Opaco / Mat / Matt / Matt / Mate / Матовый*
- 2** TECNOGRES - LV890 - 322 EMPERADOR
- 3** 407 AGATA  
*Opaco / Mat / Matt / Matt / Mate / Матовый*
- 4** G56 - 407 AGATA  
*Opaco / Mat / Matt / Matt / Mate / Матовый*
- 5** 407 AGATA  
*Opaco / Mat / Matt / Matt / Mate / Матовый*
- 6** 407 AGATA  
*Opaco / Mat / Matt / Matt / Mate / Матовый*



- 1 KENDO**

---

- 2 TECNOMOOD - LB857 - NCS: 3005 - G80Y**  
*Opaco / Mat / Matt / Matt / Mate / Матовый*

---

- 3 NCS: 3005 - G80Y**  
*Opaco / Mat / Matt / Matt / Mate / Матовый*

---

- 4 G56 - NCS: 3005 - G80Y**  
*Opaco / Mat / Matt / Matt / Mate / Матовый*

---

- 5 NCS: 3005 - G80Y**  
*Opaco / Mat / Matt / Matt / Mate / Матовый*

---

- 6 NCS: 3005 - G80Y**  
*Opaco / Mat / Matt / Matt / Mate / Матовый*

---

- 7 APERTURA DA SOTTO / Ouverture Par Le Dessous / Underside Opening / Eröffnung Von Unten / Apertura Por Abajo / Открытие Снизу**

---

- 8 SELECTA - NCS: 3005 - G80Y**  
*Opaco / Mat / Matt / Matt / Mate / Матовый*

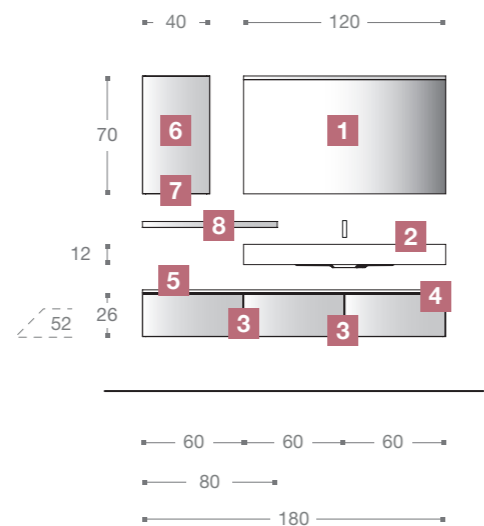

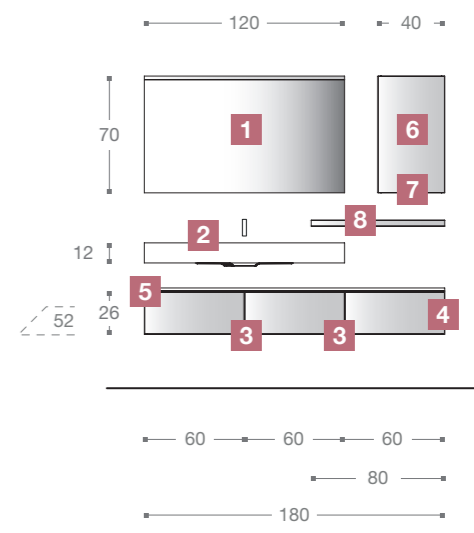

- 1 KENDO**

---

- 2 TECNOPLAN - VA015**

---

- 3 407 AGATA**  
*Lucido / Brillant / Glossy / Hochglanz / Brillo / Глянцевый*

---

- 4 PUSH PULL**  
*Push-Pull / Push-To-Open / Push-To-Open / Push Pull / Push Pull*

---

- 5 407 AGATA**  
*Lucido / Brillant / Glossy / Hochglanz / Brillo / Глянцевый*

---

- 6 407 AGATA**  
*Lucido / Brillant / Glossy / Hochglanz / Brillo / Глянцевый*

---

- 7 APERTURA DA SOTTO / Ouverture Par Le Dessous / Underside Opening / Eröffnung Von Unten / Apertura Por Abajo / Открытие Снизу**

---

- 8 SELECTA - 407 AGATA**  
*Lucido / Brillant / Glossy / Hochglanz / Brillo / Глянцевый*

- 1** UNIKO - NCS: 1505-Y70R  
*Opaco / Mat / Matt / Mate / Матовый*
- 2** NCS: 1505-Y70R - VA006 - VETRO SATINATO  
*Verre Satiné / Frosted Glass / Satiniert Glas / Cristal Satinado / Стекло матовое*
- 3** NCS: 1505-Y70R  
*Opaco / Mat / Matt / Mate / Матовый*
- 4** G56 - NCS: 1505-Y70R  
*Opaco / Mat / Matt / Mate / Матовый*
- 5** NCS: 1505-Y70R  
*Opaco / Mat / Matt / Mate / Матовый*
- 6** NCS: 1505-Y70R  
*Opaco / Mat / Matt / Mate / Матовый*
- 7** G56 - NCS: 1505-Y70R  
*Opaco / Mat / Matt / Mate / Матовый*

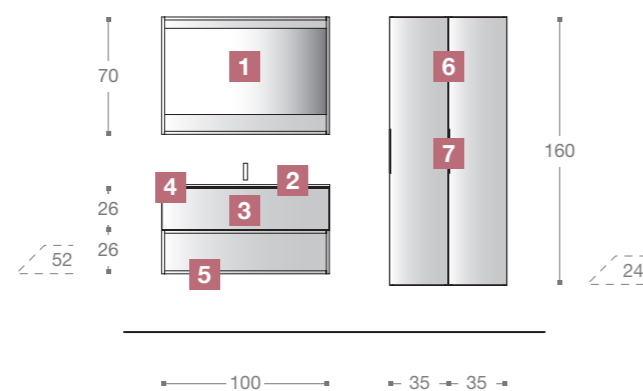



- 1** ALFA

---

- 2** SOFT - TECNOMAT

---

- 3** TECNOMAT

---

- 4** NCS: 4005 - G20Y  
*Opaco / Mat / Matt / Matt / Mate / Матовый*

---

- 5** PRESA MANIGLIA  
*Prise De Main / Integrated Pull / Geprüft  
Griffmulde / Tirador Integrado / Фрезер. ручка*

---

- 6** SELECTA - NCS: 14005 - G20Y  
*Opaco / Mat / Matt / Matt / Mate / Матовый*

---

- 7** NCS: 4005 - G20Y  
*Opaco / Mat / Matt / Matt / Mate / Матовый*

---

- 8** PRESA MANIGLIA  
*Prise De Main / Integrated Pull / Geprüft  
Griffmulde / Tirador Integrado / Фрезер. ручка*

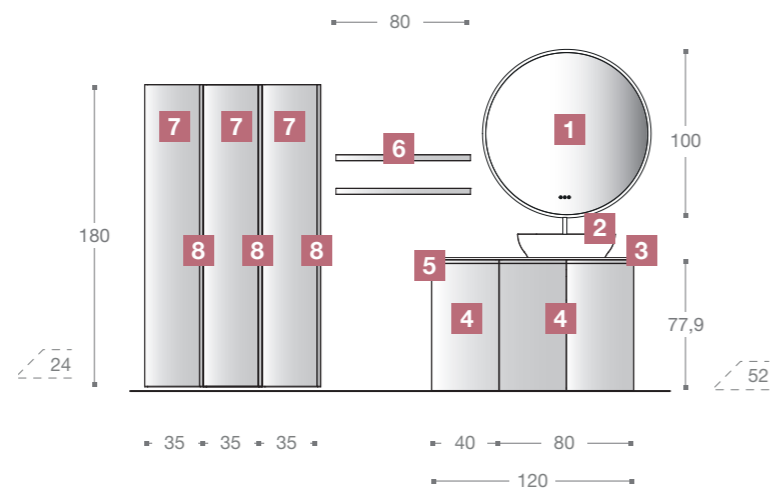

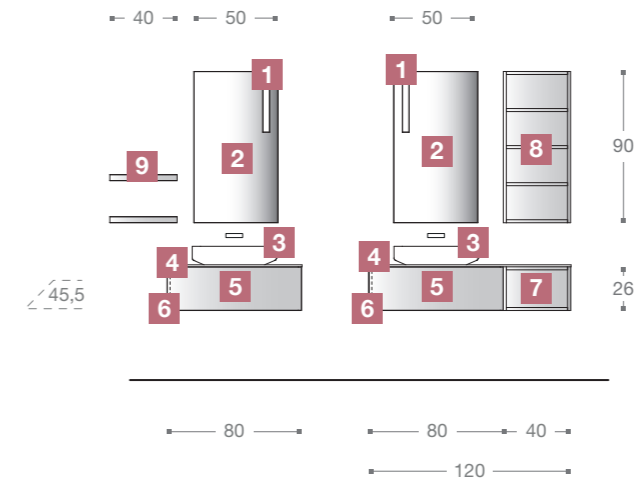

- 1 CITY**
- 2 SPECCHIO FILO LUCIDO**  
*Miroir simple / Simple mirror / Spiegel / Espejo canto pulido / Зеркало с полированными краями*
- 3 FRAME - TECNOMAT - NCS: 5020-B**  
*Opaco / Mat / Matt / Matt / Mate / Матовый*
- 4 TECNOMOOD - NCS: 5020-B**  
*Opaco / Mat / Matt / Matt / Mate / Матовый*
- 5 NCS: 5020-B**  
*Opaco / Mat / Matt / Matt / Mate / Матовый*
- 6 G64 - BIANCO**  
*Blanc / White / Weiß / Bianco / Белый*
- 7 NCS: 5020-B**  
*Opaco / Mat / Matt / Matt / Mate / Матовый*
- 8 NCS: 5020-B**  
*Opaco / Mat / Matt / Matt / Mate / Матовый*
- 9 SELECTA - NCS: 5020-B**  
*Opaco / Mat / Matt / Matt / Mate / Матовый*





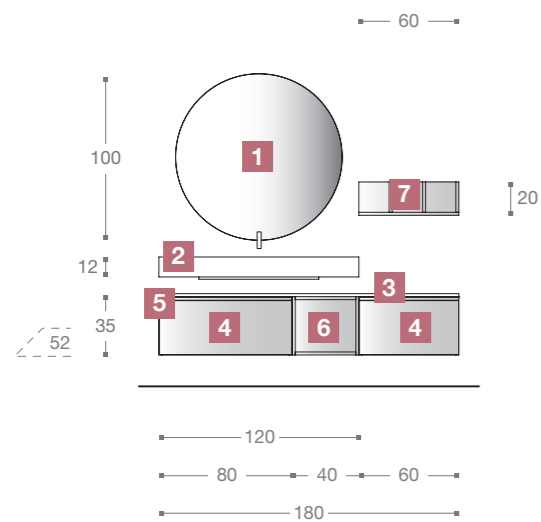

- 1 ERGO**

---

- 2 TECNOGRES - LV891 - 320 NERO ATLANTE**

---

- 3 400 ANTRACITE**  
*Opaco / Mat / Matt / Matt / Mate / Матовый*

---

- 4 400 ANTRACITE**  
*Opaco / Mat / Matt / Matt / Mate / Матовый*

---

- 5 PRESA MANIGLIA**  
*Prise De Main / Integrated Pull / Geffräster Griffmulde / Tirador Integrado / Фрезер. ручка*

---

- 6 939 RIGATO IMPERIALE**

---

- 7 939 RIGATO IMPERIALE**





**IT.** Una selezione di vari materiali che creano un perfetto equilibrio per una composizione adatta a molteplici soluzioni bagno.

**FR.** Une sélection de plusieurs matériaux qui créent un équilibre parfait pour un ensemble de salle de bains capable de satisfaire toute exigence.

**EN.** A selection of various materials that create a perfect balance for a composition suitable for multiple bathroom solutions.

**DE.** Eine Auswahl verschiedener Materialien, die ein perfektes Gleichgewicht für eine Komposition schaffen, die für mehrere Badlösungen geeignet ist.

**ES.** Una selección de varios materiales que crean un perfecto equilibrio para una composición adapta a múltiples cuartos de baño.

**RU.** Выбор различных материалов, которые создают идеальный баланс композиции, подходящей для различных решений в ванной комнате.

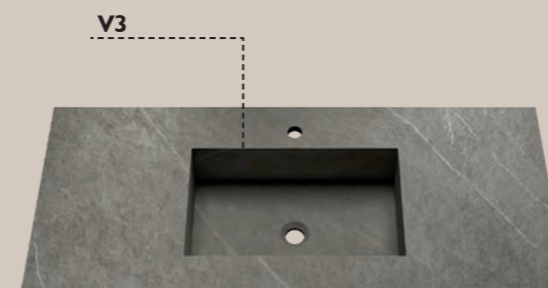
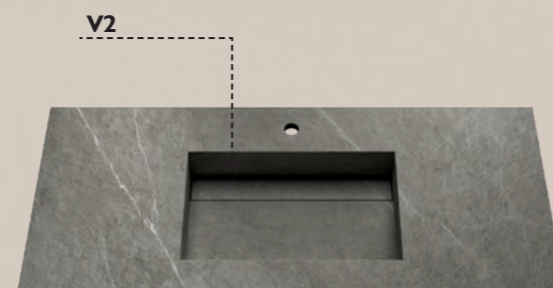
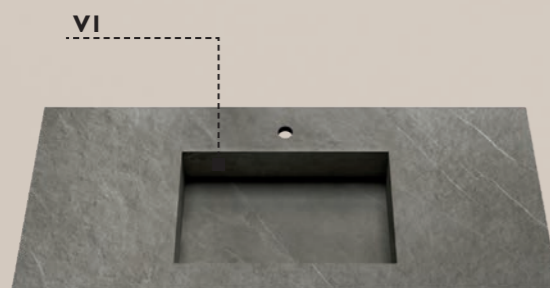

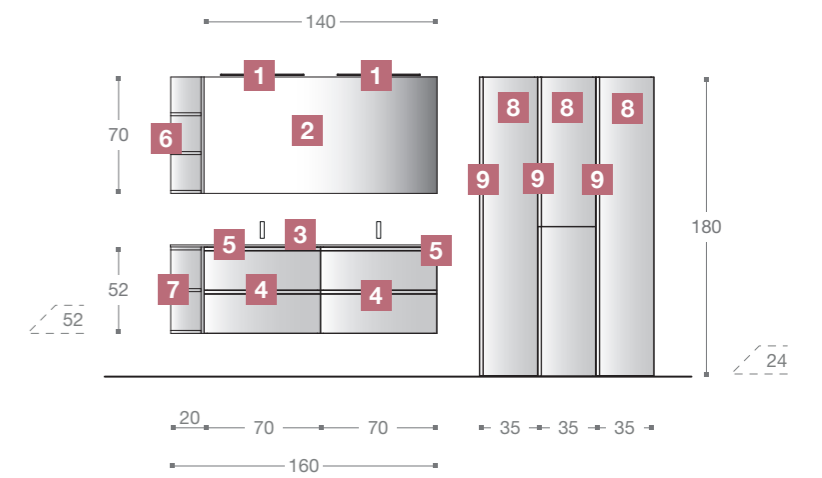

**1** FLAT 500

**2** SPECCHIO FILO LUCIDO  
*Miroir simple / Simple mirror / Spiegel / Espejo  
canto pulido / Зеркало с полированными краями*

**3** TECNOMAT - VA018

**4** 407 AGATA  
*Opaco / Mat / Matt / Matt / Mate / Матовый*

**5** PRESA MANIGLIA  
*Prise De Main / Integrated Pull / Geprüster  
Griffmulde / Tirador Integrado / Фрезер. ручка*

**6** 937 ROVERE ELEGANCE

**7** 937 ROVERE ELEGANCE

**8** 407 AGATA  
*Opaco / Mat / Matt / Matt / Mate / Матовый*

**9** PRESA MANIGLIA  
*Prise De Main / Integrated Pull / Geprüster  
Griffmulde / Tirador Integrado / Фрезер. ручка*



**IT.** Portalavabi con presa maniglia laccati opaco 407 Agata, base a giorno laterale in essenza 937 Rovere Elegance; top in Tecnomat bianco opaco con doppia vasca integrata. Specchio filo lucido con due lampade Flat L.50 cm finitura cromo. Nella pagina a fianco dettaglio pensile a giorno L.20 cm in essenza 937 Rovere Elegance.

**FR.** Meuble sous-vasque avec prise de mains laqués 407 Agata mat, élément à jour latéral en bois 937 Rovere Elegance; Plan en Tecnomat blanc mat avec 2 vasques moulées. Miroir simple avec lampes chromées Flat L.50. Dans la page à côté détail de l'armoire à jour L.20 en bois 937 Rovere Elegance.

**EN.** Washbasin units with integrated pull matt 407 Agata lacquered, open side base unit in essenza 937 Rovere Elegance; top in matt white Tecnomat with integrated double basin. Mirror with two Flat lamps L.50 cm in chrome finish. On the opposite page detail of open wall unit L.20 cm in essenza 937 Rovere Elegance.

**DE.** Waschtischunterschranke mit matt lackiertem 407 Agata gefrästem Griffmulde, offenes Seitenelement in essenza 937 Rovere Elegance; Platte in Tecnomat matt weiß mit integriertem Doppelwaschbecken. Spiegel mit zwei Flat Lampen L.50 cm in Chromausführung. Auf der gegenüberliegenden Seite Detail des offenen Hangeschranks L.20 cm in Essenza 937 Rovere Elegance.

**ES.** Portalavabos con tiradores integrados lacados mate 407 Agata, módulos abiertos laterales en acabado madera 937 Rovere Elegance; encimera en Tecnomat blanco mate con doble lavabo integrado. Espejo canto pulido con dos lámparas Flat A.50 cm acabado cromo. En la página al lado detalle armario abierto A.20 cm en acabado madera 937 Rovere Elegance.

**RU.** Тумбы под раковину с фрезерованной ручкой в матовом лаке 407 Agata, боковая открытая тумба в отделке под дерево 937 Rovere Elegance Essence; топ из белого матового Tecnomat с двойной интегрированной мойкой. Зеркало с полированными краями и двумя светильниками шир.50 см, отделка хром. На противоположной странице изображен открытый шкафчик шир.20 см в отделке под дерево 937 Rovere Elegance.

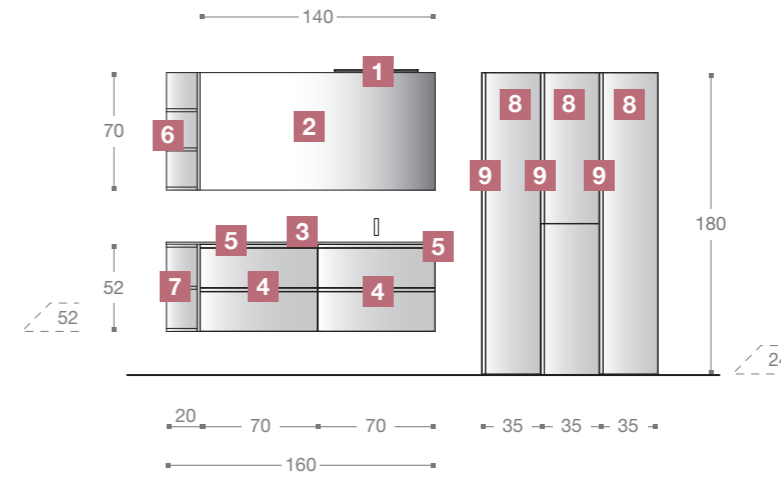

- 1** FLAT 500
- 2** SPECCHIO FILO LUCIDO  
*Miroir simple / Simple mirror / Spiegel / Espejo canto pulido / Зеркало с полированными краями*
- 3** 407 AGATA - VA006 - VETRO SATINATO  
*Verre Satiné / Frosted Glass / Satiniert Glas / Cristal Satinado / Стекло матовое*
- 4** 407 AGATA  
*Opaco / Mat / Matt / Matt / Mate / Матовый*
- 5** PRESA MANIGLIA  
*Prise De Main / Integrated Pull / Geprüft Griffmulde / Tirador Integrado / Фрезер. ручка*
- 6** 937 ROVERE ELEGANCE
- 7** 937 ROVERE ELEGANCE
- 8** 407 AGATA  
*Opaco / Mat / Matt / Matt / Mate / Матовый*
- 9** PRESA MANIGLIA  
*Prise De Main / Integrated Pull / Geprüft Griffmulde / Tirador Integrado / Фрезер. ручка*



- 1** SLIM - H58.1000

---

- 2** SPECCHIO FILO LUCIDO  
*Miroir simple / Simple mirror / Spiegel / Espejo canto pulido / Зеркало с полированными краями*

---

- 3** TOP TEXTURIZZATO - VA031 - 414 ASPARAGO  
*Opaco / Mat / Matt / Mate / Матовый*

---

- 4** 414 ASPARAGO  
*Opaco / Mat / Matt / Mate / Матовый*

---

- 5** G64 - BIANCO  
*Blanc / White / Weiß / Blanco / Белый*

---

- 6** 415 SALVIA  
*Opaco / Mat / Matt / Mate / Матовый*

---

- 7** 414 ASPARAGO  
*Opaco / Mat / Matt / Mate / Матовый*

---

- 8** 414 ASPARAGO  
*Opaco / Mat / Matt / Mate / Матовый*

---

- 9** APERTURA DA SOTTO / Ouverture Par Le Dessous / Underside Opening / Eröffnung Von Unten / Apertura Por Abajo / Открытие Снизу

---

- 10** 415 SALVIA  
*Opaco / Mat / Matt / Mate / Матовый*

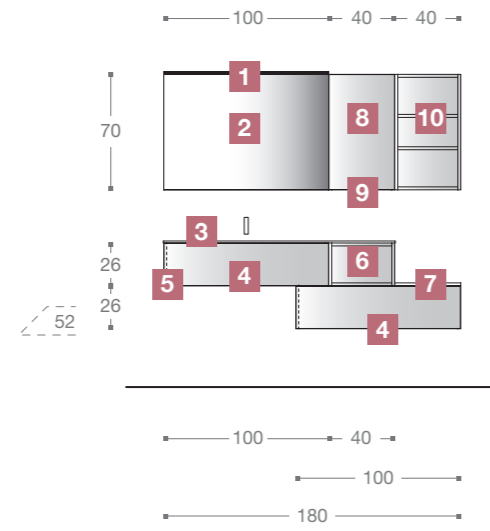

- 1** BRICK - NERO  
*Noir / Black / Schwarz / Negro / Черный*

---

- 2** IRIS - TECNOMAT - 433 NERO  
*Opaco / Mat / Matt / Mate / Матовый*

---

- 3** TECNOLAM - 260 IMPERO

---

- 4** TECNOLAM - 264 ROVERE TEXAS

---

- 5** G56 - 433 NERO  
*Opaco / Mat / Matt / Mate / Матовый*

---

- 6** SELECTA - 433 NERO  
*Opaco / Mat / Matt / Mate / Матовый*

---

- 7** TECNOLAM - 264 ROVERE TEXAS

---

- 8** G56 - 433 NERO  
*Opaco / Mat / Matt / Mate / Матовый*

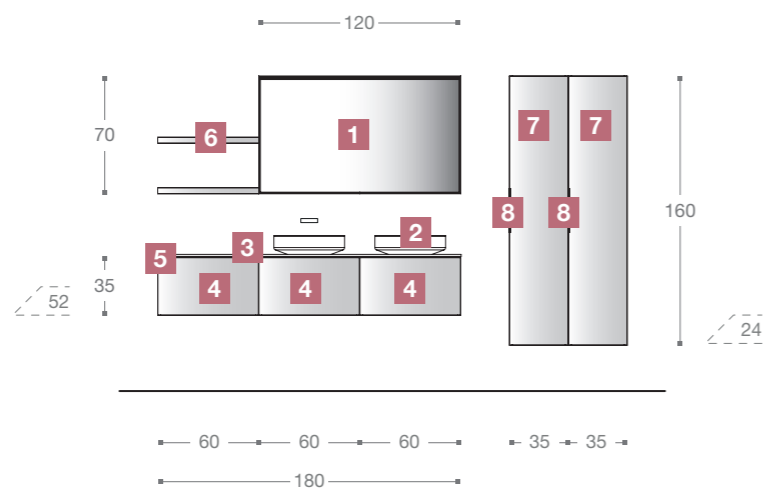



765 / 865 CALACATTA - LUCIDO / OPACO



745 GRIS EXPO - LUCIDO  
QUARZO



749 ULTRABIANCO - LUCIDO  
QUARZO

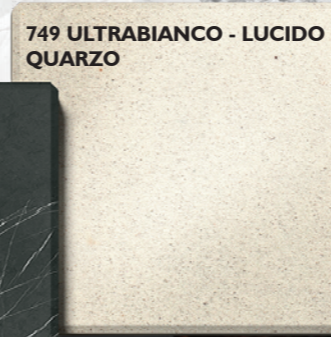

767 SHARA NOIR - LUCIDO



763 / 863 TRAVERTINO  
LUCIDO / OPACO



742 / 842 GREY STONE  
LUCIDO / OPACO



762 / 862 EMPERADOR DARCK  
LUCIDO / OPACO



750 NERO - LUCIDO  
QUARZO



708 / 808 ROSA PORTOGALLO  
LUCIDO / OPACO



747 ROUGUI LENA  
LUCIDO - QUARZO



761 / 861 ARABESCATO  
LUCIDO / OPACO



766 / 866 GRIGIO CARNICO  
LUCIDO / OPACO



764 / 864 STATUARIO  
LUCIDO / OPACO



746 MARENGO - LUCIDO  
QUARZO



714 / 814 VERDE GUATEMALA  
LUCIDO / OPACO



748 NOKA - LUCIDO  
QUARZO



701 / 700 BIANCO CARRARA - LUCIDO / OPACO



735 / 835  
NERO MARQUINIA  
LUCIDO / OPACO



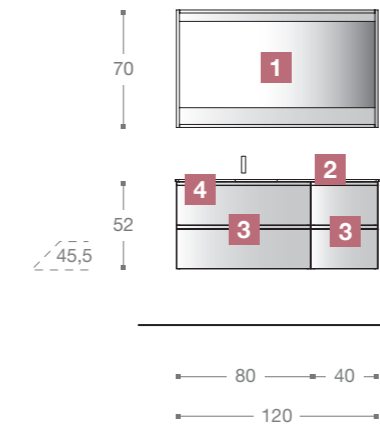

1 UNIKO - 936 ROVERE CLASSIC

2 CERAMICA - TK108  
Ceramique / Ceramic / Keramik / Cerámica /  
Керамика

3 BIANCO OPACO  
Blanc Mat / White Matt / Weiß Matt / Blanco  
Mate / Белый Матовый

4 936 ROVERE CLASSIC

5 PRESA MANIGLIA  
Prise De Main / Integrated Pull / Geöffnet  
Griffmulde / Tirador Integrado / Фрезер. ручка



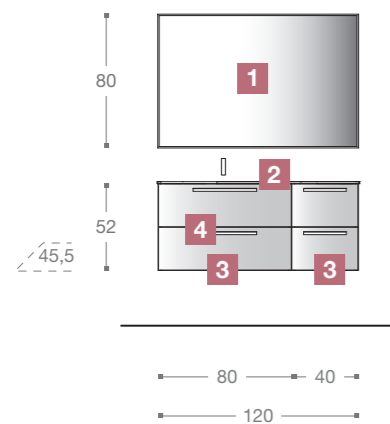

**1 GENESIS**

**CERAMICA - TK108**  
Ceramique / Ceramic / Keramik / Cerámica /  
Керамика

**2**

**BIANCO OPACO**  
Bianc Mat / White Matt / Weiß Matt / Blanco  
Mate / Белый Матовый

**3**

**407 AGATA**  
Opaco / Mat / Matt / Matt / Mate / Матовый

**4**

**G59 - 407 AGATA**  
Opaco / Mat / Matt / Matt / Mate / Матовый



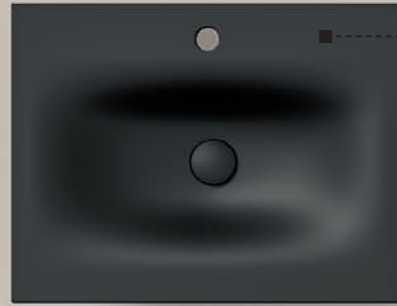

TK100 - 46x61



TK106 - 46x101

TK101 - 46x81

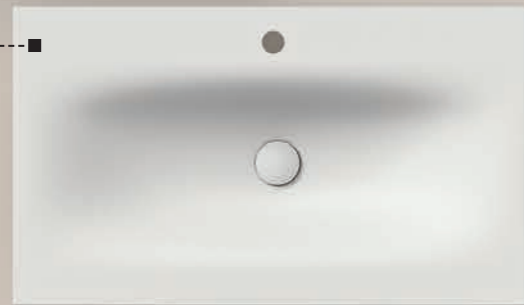

TK116 - 46x101



TK102 - 46x101

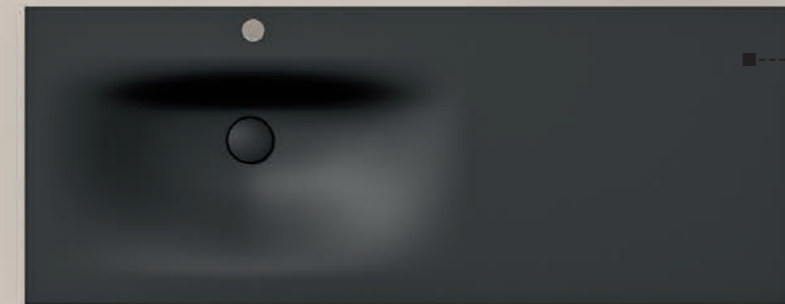

TK108 - 46x121

TK103 - 46x121

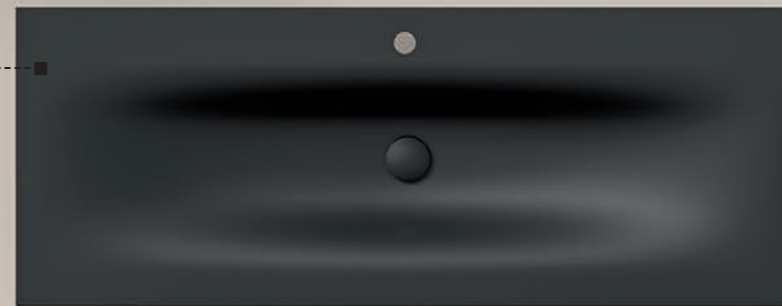

TK118 - 46x121

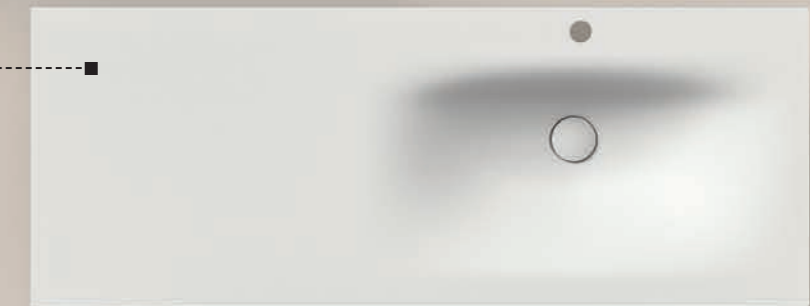

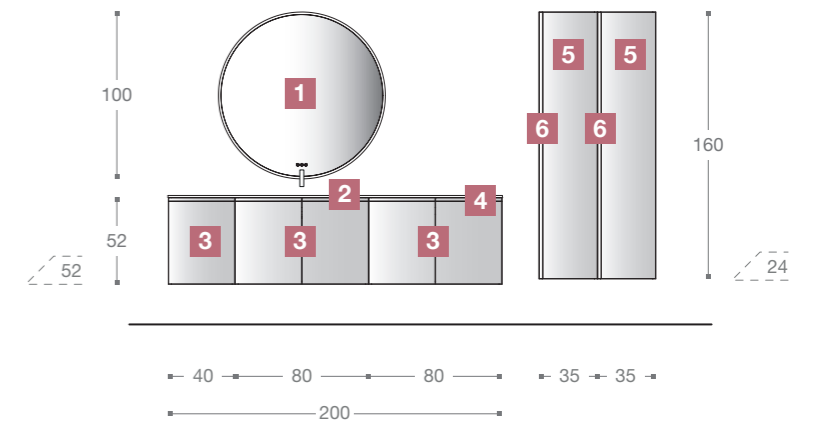

- 1 ALFA**

---

- 2 TECNOMAT - VA019**

---

- 3 415 SALVIA**  
*Opaco / Mat / Matt / Matte / Матовый*

---

- 4 PRESA MANIGLIA**  
*Prise De Main / Integrated Pull / Geprüft  
Griffmulde / Tirador Integrado / Фрезер. ручка*

---

- 5 415 SALVIA**  
*Opaco / Mat / Matt / Matte / Матовый*

---

- 6 PRESA MANIGLIA**  
*Prise De Main / Integrated Pull / Geprüft  
Griffmulde / Tirador Integrado / Фрезер. ручка*

- 1** EDEN

---

- 2** TECNOPLAN - VA015

---

- 3** 403 GRIGIO ARGENTO  
*Lucido / Brillant / Glossy / Hochglanz / Brillo / Глянцевый*

---

- 4** PRESA MANIGLIA  
*Prise De Main / Integrated Pull / Gefräster Griffmulde / Tirador Integrado / Фрезер. ручка*

---

- 5** 403 GRIGIO ARGENTO  
*Lucido / Brillant / Glossy / Hochglanz / Brillo / Глянцевый*

---

- 6** PRESA MANIGLIA  
*Prise De Main / Integrated Pull / Gefräster Griffmulde / Tirador Integrado / Фрезер. ручка*

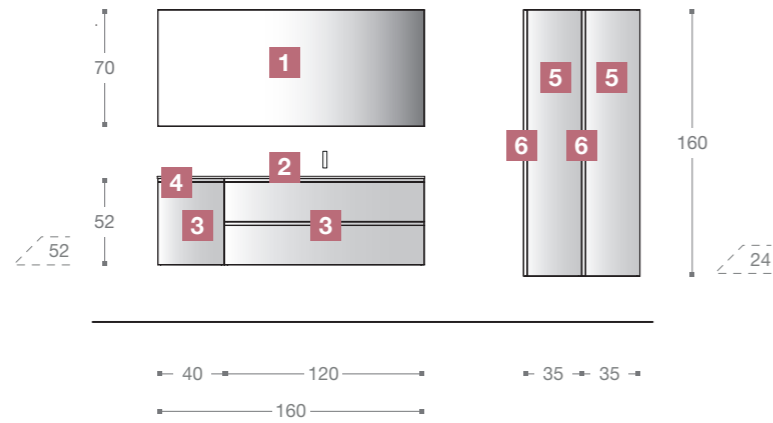

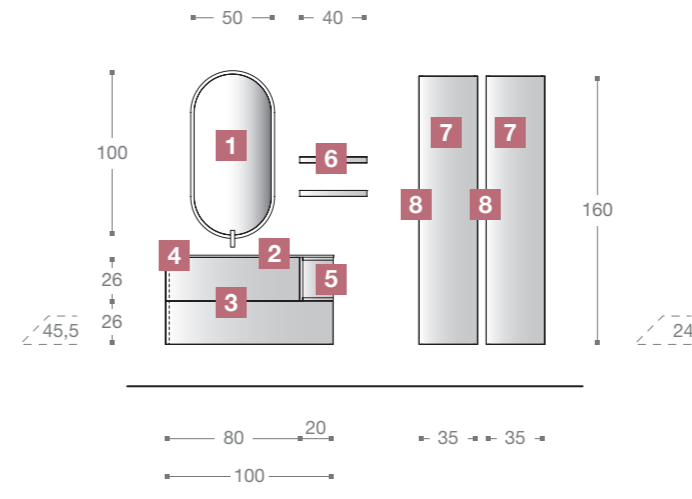

- 1 SHADE**
- 2 406 SETA - VA022 - VETRO SATINATO**  
Verre Satiné / Frosted Glass / Satiniert Glas / Cistal Satinado / Стекло матовое
- 3 406 SETA**  
Opaco / Mat / Matt / Matt / Mate / Матовый
- 4 G64 - BIANCO**  
Blanc / White / Weiß / Blanco / Белый
- 5 938 ROVERE NORDICO**
- 6 SELECTA - 406 SETA**  
Opaco / Mat / Matt / Matt / Mate / Матовый
- 7 938 ROVERE NORDICO**
- 8 G64 - BIANCO**  
Blanc / White / Weiß / Blanco / Белый

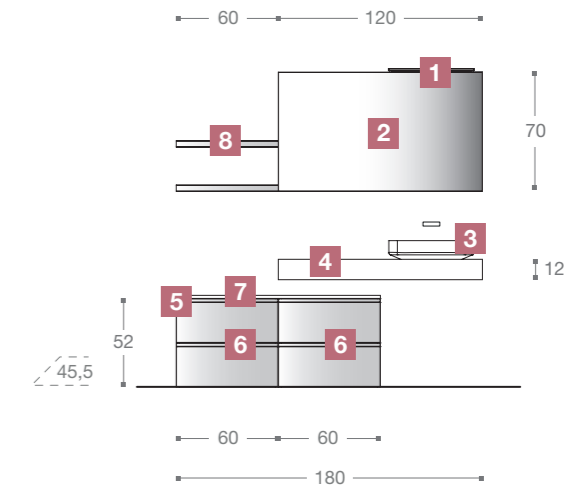

- 1** SURA 500 - BIANCO  
*Blanc / White / Weiß / Blanco / Белый*

---

- 2** SPECCHIO FILO LUCIDO  
*Miroir simple / Simple mirror / Spiegel / Espejo canto pulido / Зеркало с полированными краями*

---

- 3** FRAME - TENCOMAT - BIANCO OPACO  
*Blanc Mat / White Matt / Weiß Matt / Blanco Mate / Белый Матовый*

---

- 4** TECNOGRES - 330 STATUARIO ALTISSIMO

---

- 5** 417 LATTE  
*Opaco / Mat / Matt / Matt / Mate / Матовый*

---

- 6** 417 LATTE  
*Opaco / Mat / Matt / Matt / Mate / Матовый*

---

- 7** PRESA MANIGLIA  
*Prise De Main / Integrated Pull / Geprüft Griffmulde / Tirador Integrado / Фрезер. ручка*

---

- 8** SELECTA - 417 LATTE  
*Opaco / Mat / Matt / Matt / Mate / Матовый*





**IT.** A fianco: dettaglio mensola Selecta, un estruso in alluminio laccato opaco 417 Latte e dettaglio specchio filo lucido con lampada Sura L.50 cm in finitura bianco.

**FR.** A côté: le détail de l'étagère Selecta, en plein aluminium laqué mat 417 Latte et détail du miroir avec lampe Sura L.50 cm en finition blanc.

**EN.** On the side: detail of Selecta shelf, an aluminum extruded 417 Latte matt lacquered and detail of the mirror with Sura lamp L.50 cm in white finish.

**DE.** Seitlich: Detail des Selecta Regals, ein stranggepresstes Aluminium matt lackiert 417 Latte und Detail des Spiegels mit Sura Lampe L.50 cm in weißer Ausführung.

**ES.** Al lado: detalle repisa Selecta, un extruido de aluminio lacado mate 417 Latte y detalle espejo canto pulido con lámpara Sura A.50 cm en acabado blanco.

**RU.** Сбоку деталь полочки Selecta из экструдированного алюминия в матовом лаке Latte 417 и деталь зеркала с полированными краями и светильником Sura шир.50 см в белом цвете.



- 1** ESTRO

---

- 2** TECNOMAT - VA019

---

- 3** 939 RIGATO IMPERIALE

---

- 4** 939 RIGATO IMPERIALE

---

- 5** PRESA MANIGLIA  
*Prise De Main / Integrated Pull / Gefräster Griffmulde / Tirador Integrado / Фрезер. ручка*

---

- 6** 408 MOKA  
*Opaco / Mat / Matt / Mate / Матовый*

---

- 7** APERTURA DA SOTTO / *Ouverture Par Le Dessous / Underside Opening / Eröffnung Von Unten / Apertura Por Abajo / Открытие Снизу*

---

- 8** 939 RIGATO IMPERIALE

---

- 9** PRESA MANIGLIA  
*Prise De Main / Integrated Pull / Gefräster Griffmulde / Tirador Integrado / Фрезер. ручка*

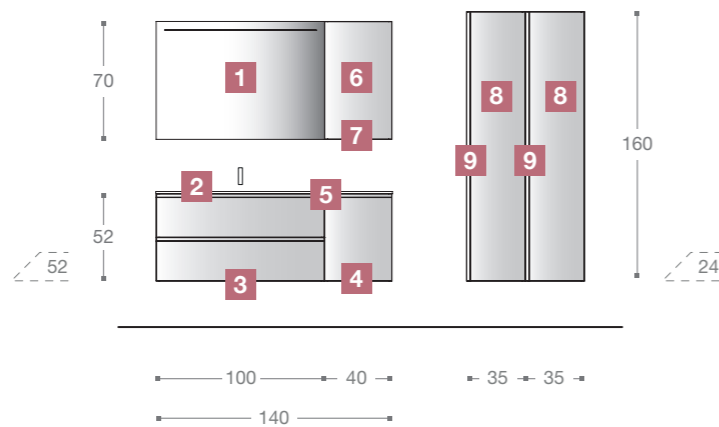



- 1** ESTRO

---

- 2** TECNOMAT - VA019

---

- 3** 939 RIGATO IMPERIALE

---

- 4** G70.V - 408 MOKA  
*Opaco / Mat / Matt / Mate / Матовый*

---

- 5** 408 MOKA  
*Opaco / Mat / Matt / Mate / Матовый*

---

- 6** PUSH PULL  
*Push-Pull / Push-To-Open / Push-To-Open / Push Pull / Push Pull*

---

- 7** 939 RIGATO IMPERIALE

---

- 8** PUSH PULL  
*Push-Pull / Push-To-Open / Push-To-Open / Push Pull / Push Pull*

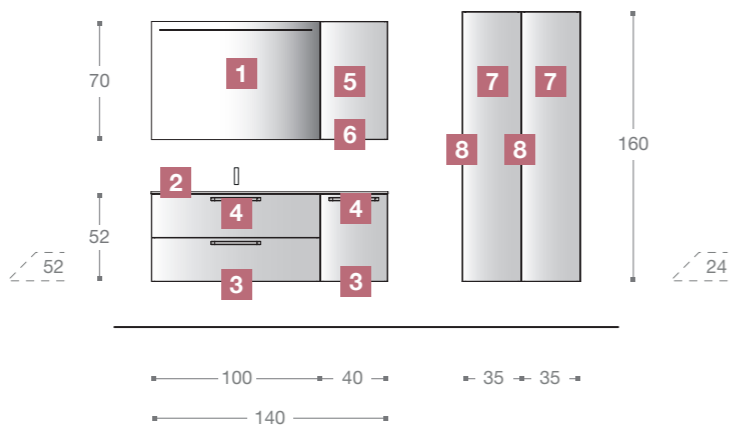

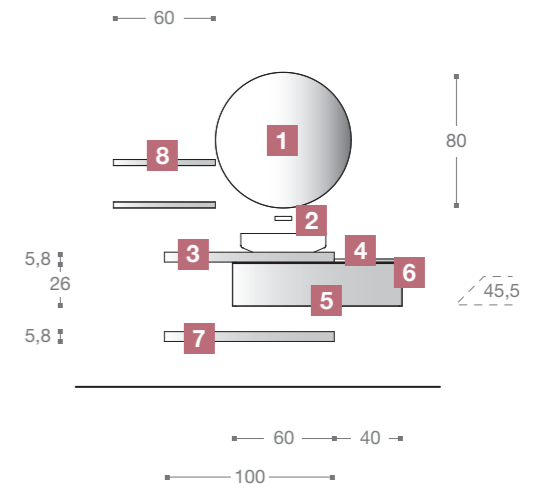

- 1 ERGO**
- 2 FRAME - TENCOMAT - BIANCO OPACO**  
*Blanc Mat / White Matt / Weiß Matt / Blanco Mate / Белый Матовый*
- 3 948 VINTAGE AVANA**
- 4 400 ANTRACITE**  
*Opaco / Mat / Matt / Mate / Матовый*
- 5 400 ANTRACITE**  
*Opaco / Mat / Matt / Mate / Матовый*
- 6 G56 - 400 ANTRACITE**  
*Opaco / Mat / Matt / Mate / Матовый*
- 7 948 VINTAGE AVANA**
- 8 SELECTA - 400 ANTRACITE**  
*Opaco / Mat / Matt / Mate / Матовый*



**IT.** Dettaglio dell'asimmetria che si crea: fra il top H.5,8 cm in essenza 948 Vintage Avana, la base con maniglia G56 laccata opaco 400 Antracite e il top H.1,8 cm laccato opaco 400 Antracite.

**FR.** Détail de l'équilibre asymétrique qu'on crée: parmi le plan H.5,8 cm en finition bois 948 Vintage Avana, l'élément bas avec poignée G56 laquée 400 Antracite mat et le plan H.1,8 cm laqué mat 400 Antracite.

**EN.** Detail of the asymmetry created between the H.5,8 cm top in essenza 948 Vintage Avana, the base unit with the 400 Antracite matt lacquered G56 handle and the H 1,8 cm top in 400 Antracite matt.

**DE.** Detail der Asymmetrie zwischen der Platte H.5,8 cm aus 948 Vintage Avana Holz, dem Unterschrank mit matt lackiertem 400 Antracite G56 Griff und der matt lackierte 400 Antracite Platte H 1,8 cm.

**ES.** Detalle de la asimetría que se crea: entre la encimera H.5,8 en acabado madera 948 Vintage Avana, el módulo con tirador G56 lacada mate 400 Antracite y la encimera H.1,8 cm lacado mate 400 Antracite.

**RU.** Деталь созданной асимметрии между столешницей выс. 5,8 см в цвете 948 Vintage Avana, тумбой с ручкой G56 в матовом лаке 400 Antracite и топом выс. 1,8 см в матовом лаке 400 Antracite.

**IT.** Dettaglio specchio Ergo retroilluminato luce Led e lavabo sopra piano Frame L.50 P.35 H.11 cm in Tecnomat bianco opaco.

**FR.** Détail du miroir Ergo rétroéclairé avec lumières led et vasque à poser Frame L.50 P.35 H.11 cm en Tecnomat blanc mat.

**EN.** Detail of Ergo mirror backlit with LED light and Frame countertop basin W.50 D.35 H.11 cm in Tecnomat matt white.

**DE.** Detail des Ergo-Spiegels mit LED-Hintergrundbeleuchtung und des Aufsatzwaschbeckens Frame B.50 T.35 H.11 cm in Tecnomat mattweiß.

**ES.** Detalle espejo Ergo retroiluminado luz Led y lavabo sobrencimera Frame A.50 P.35 H.11 cm en Tecnomat blanco mate.

**RU.** Деталь зеркала Ergo со светодиодной подсветкой и накладной раковины Frame шир.50 гл.35 выс.11 см из матового белого Tecnomat.

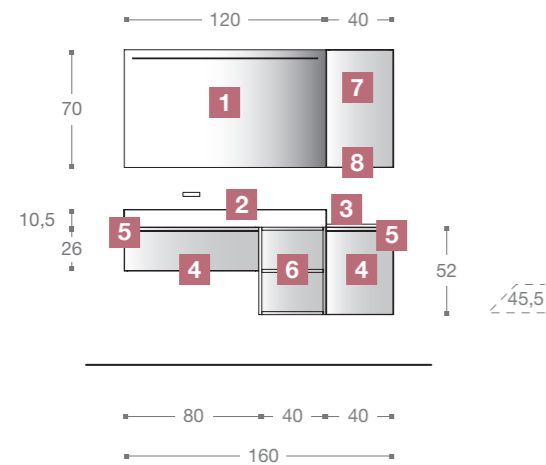

- 1** ESTRO

---

- 2** TECNOMAT - TNB052

---

- 3** 936 ROVERE CLASSIC

---

- 4** 936 ROVERE CLASSIC

---

- 5** PRESA MANIGLIA  
*Prise De Main / Integrated Pull / Gefräster Griffmulde / Tirador Integrado / Фрезер. ручка*

---

- 6** 936 ROVERE CLASSIC

---

- 7** 936 ROVERE CLASSIC

---

- 8** APERTURA DA SOTTO / *Ouverture Par Le Dessous / Underside Opening / Eröffnung Von Unten / Apertura Por Abajo / Открытие Снизу*





**IT.** Sopra particolare della base a giorno P.45,5 cm in essenza 936 Rovere Classic. Nella pagina precedente dettaglio del top L.120 P.46 H.10,5 cm scatolato in Tecnomat bianco opaco con piano d'appoggio.

**FR.** En haut détail de l'élément bas ajouré P.45,5 cm en finition bois 936 Rovere Classic. Dans la page précédente détail du plan L.120 P.46 H.10,5 en Tecnomat blanc mat avec plage sur le côté.

**EN.** Above detail of the open base unit D.45,5 cm in essenza 936 Rovere Classic. On the previous page detail of the wall mounted top W.120 D.46 H.10,5 cm in Tecnomat matt white with support surface.

**DE.** Oben Detail des offenen Elements D.45,5 cm in Essenza 936 Rovere Classic. Auf der vorherigen Seite Detail des freihängenden Waschtisches B.120 T.46 H.10,5 cm in Tecnomat matt weiß mit Ablagefläche.

**ES.** Arriba particular del módulo abierto P.45,5 cm en acabado madera 936 Rovere Classic. En la página anterior detalle de la encimera A.120 P.46 H.10,5 cm suspendida en Tecnomat blanco mate con plano de apoyo.

**RU.** Вверху деталь открытой тумбы гл.45,5 см в отделке под дерево 936 Rovere Classic. На предыдущей странице деталь высокого топа шир.120 гл.46 выс.10,5 см из белого матового Tecnomat.



# TOP TECNOMAT

Plan En Tecnomat / Tecnomat Top / Tecnomat Waschtisch / Encimera Tecnomat / Ton I3 Tecnomat

Plan En Tecnomat / Tecnomat Top / Tecnomat Waschtisch / Encimera Tecnomat / Ton I3 Tecnomat

# TOP TECNOMAT

TNB050 - 46x100



TNB060 - 46x100



TNB056 - 46x160



TNB052 - 46x120

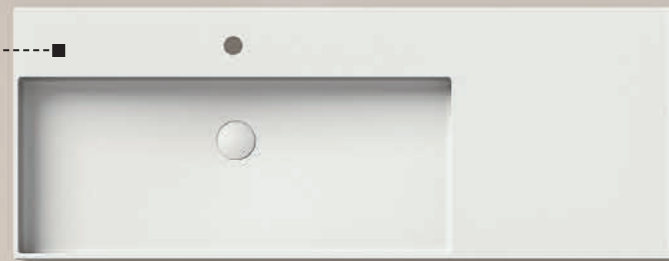

TNB066 - 46x160

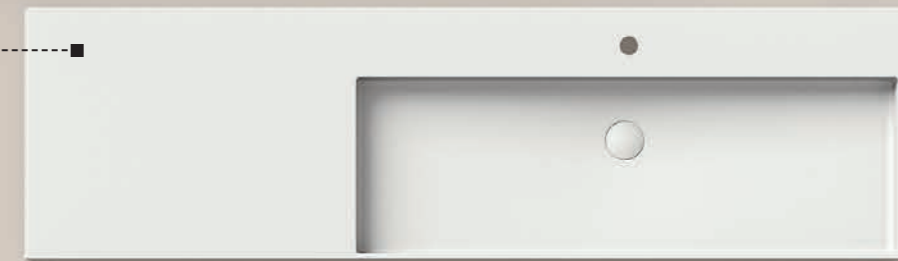

TNB062 - 46x120



TNB039 - 32x50



TNB044 - 46x80



TNB042 - 46x60



TNB054 - 46x140



TNB040 - 46x50



TNB048 - 46x120



TNB064 - 46x140



TNB038 - 30x30



TNB040 - 46x50



TNB049 - 46x120



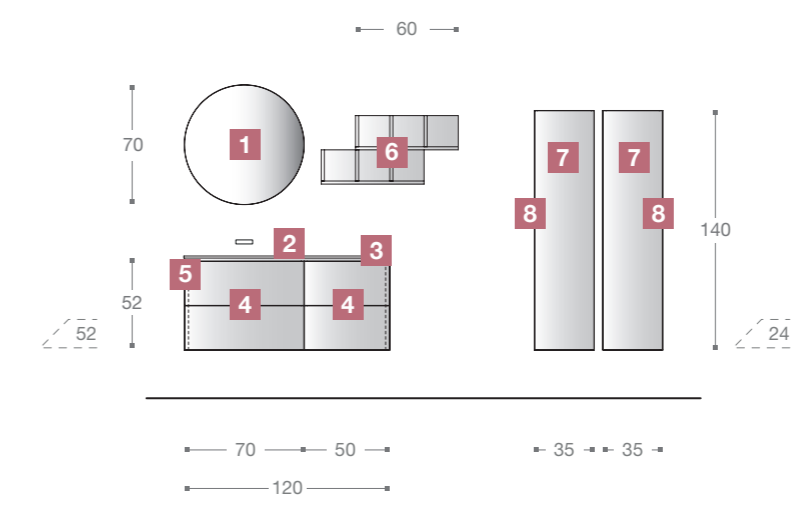

- 1** ERGO

---

- 2** TECNOLITE - LB856 - 121

---

- 3** 937 ROVERE ELEGANCE

---

- 4** 417 LATTE  
*Opaco / Mat / Matt / Malt / Mate / Матовый*

---

- 5** G64 - BIANCO  
*Blanc / White / Weiß / Blanco / Белый*

---

- 6** 937 ROVERE ELEGANCE

---

- 7** 417 LATTE  
*Opaco / Mat / Matt / Malt / Mate / Матовый*

---

- 8** G64 - BIANCO  
*Blanc / White / Weiß / Blanco / Белый*

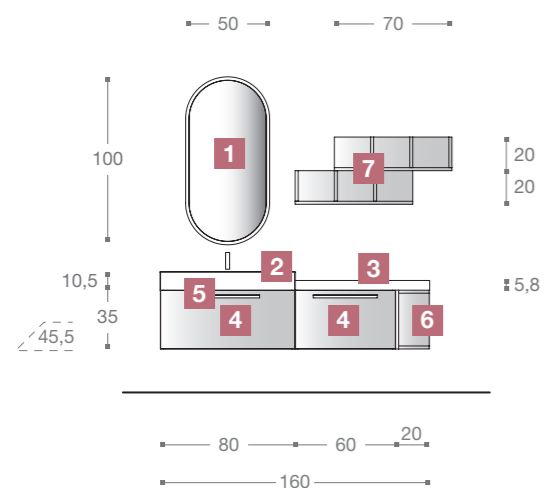

- 1** SHADE

---

- 2** TECNOMAT - TNB044

---

- 3** 937 ROVERE ELEGANCE

---

- 4** 407 AGATA  
*Opaco / Mat / Matt / Matt / Mate / Матовый*

---

- 5** G59 - 407 AGATA  
*Opaco / Mat / Matt / Matt / Mate / Матовый*

---

- 6** 407 AGATA  
*Opaco / Mat / Matt / Matt / Mate / Матовый*

---

- 7** 937 ROVERE ELEGANCE





**IT.** Sopra dettaglio del lavabo in Tecnomat L.80 P.46 H.10,5 bianco opaco con piano d'appoggio per miscelatore e particolare della base a giorno con un lato aperto, laccata opaco 407 Agata.

**FR.** En haut détail du plan en Tecnomat L.80 P.46 H.10,5 blanc mat avec plage pour le mitigeur et détail de l'élément ajouré avec un côté ouvert, laqué mat 407 Agata.

**EN.** Above detail of the Tecnomat washbasin W.80 D.46 H.10,5 matt white with countertop basin for mixer and detail of the open-sided base unit in matt 407 Agata.

**DE.** Oben Detail des Tecnomat Waschbeckens B.80 T.46 H.10,5 matt weiß mit Ablagefläche für Mischer und Detail des offenen Elements mit einer matt lackierten 407 Agata offenen Seite.

**ES.** Arriba detalle del lavabo en Tecnomat A.80 P.46 H.10,5 blanco mate con plano de apoyo para grifo y particular del módulo abierto con un lado abierto, lacado mate 407 Agata.

**RU.** Вверху деталь раковины из белого матового Tecnomat шир.80 гл.46 выс.10,5 см с опорной поверхностью для смесителя и деталь открытой тумбы с одной открытой стороной в матовом лаке 407 Agata.



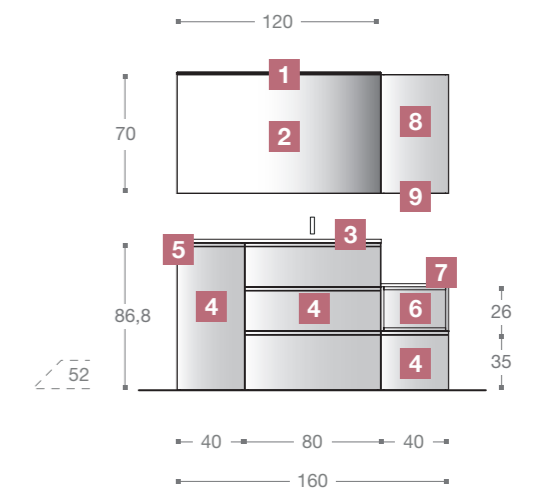

- 1** SLIM - H58.1200

---

- 2** SPECCHIO FILO LUCIDO  
*Miroir simple / Simple mirror / Spiegel / Espejo canto pulido / Зеркало с полированными краями*

---

- 3** TECNOGRES - LV892 - 323 PIETRA GREY

---

- 4** 416 CRETA  
*Opaco / Mat / Matt / Mate / Матовый*

---

- 5** PRESA MANIGLIA  
*Prise De Main / Integrated Pull / Geprüft Griffmulde / Tirador Integrado / Фрезер. ручка*

---

- 6** 935 ROVERE TITANIO

---

- 7** 935 ROVERE TITANIO

---

- 8** 935 ROVERE TITANIO

---

- 9** APERTURA DA SOTTO / *Ouverture Par Le Dessous / Underside Opening / Eröffnung Von Unten / Apertura Por Abajo / Открытие Снизу*

**IT.** A fianco dettaglio base portalavabo con presa maniglia laccata opaco 416 Creta e cassetto aperto con all'interno i divisori in metallo della serie Row. Nella pagina seguente particolare vasca integrata in Tecnogres finitura 323 Pietra Grey con piletta a vista.

**FR.** A côté le détail du meuble sous-vasque avec prise de main laqué 416 Creta mat, avec tiroir ouvert et à l'intérieur les diviseurs en métal de la collection Row. A la page suivante, détail de la vasque moulée en Tecnogres 323 Pietra Grey avec bonde visible.

**EN.** Alongside a detail of washbasin base unit with matt lacquered 416 Creta integrated pull and open drawer with metal dividers from the Row series inside. On the following page detail of integrated basin in Tecnogres finish 323 Pietra Grey with visible waste.

**DE.** Daneben Detail des Waschtischunterschrankes mit matt lackiertem 416 Creta Griff und offener Schublade mit Metalltrennsteg der Serie Row im Inneren. Auf der folgenden Seite ein Detail des integrierten Waschbeckens in Tecnogres-Finish 323 Pietra Grey mit sichtbarem Ablauf.

**ES.** Al lado detalle portalavabo con tirador integrado lacado mate 416 Creta y cajón abierto con divisorios de metal de la serie Row por adentro. En la página siguiente particular cuba integrada en Tecnogres acabado 323 Pietra Grey con válvula visible.

**RU.** Сбоку деталь тумбы под раковину с ручкой в матовом лаке Creta 416 и открытый ящик с металлическими разделителями для ящика серии Row. На следующей странице деталь встроенной раковины с отделкой Tecnogres 323 Pietra Grey с видимым сливом.



- 1** SURA 500 - BIANCO  
*Blanc / White / Weiß / Blanco / Белый*

---

- 2** SPECCHIO FILO LUCIDO  
*Miroir simple / Simple mirror / Spiegel / Espejo canto pulido / Зеркало с полированными краями*

---

- 3** TECNOMAT - TNB042

---

- 4** 937 ROVERE ELEGANCE

---

- 5** 937 ROVERE ELEGANCE

---

- 6** 937 ROVERE ELEGANCE

---

- 7** G59 - 417 LATTE  
*Opaco / Mat / Matt / Матовый*

---

- 8** 937 ROVERE ELEGANCE

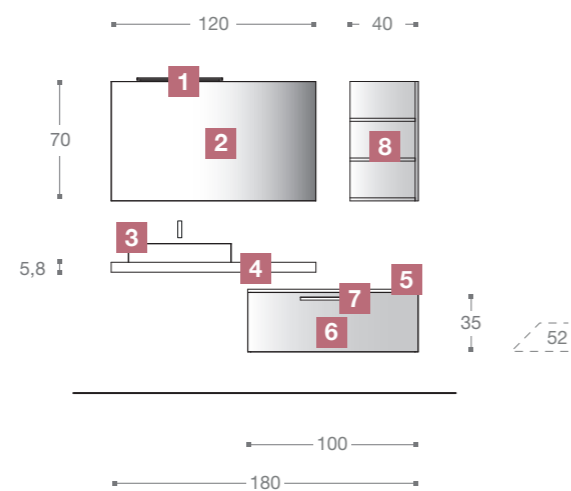

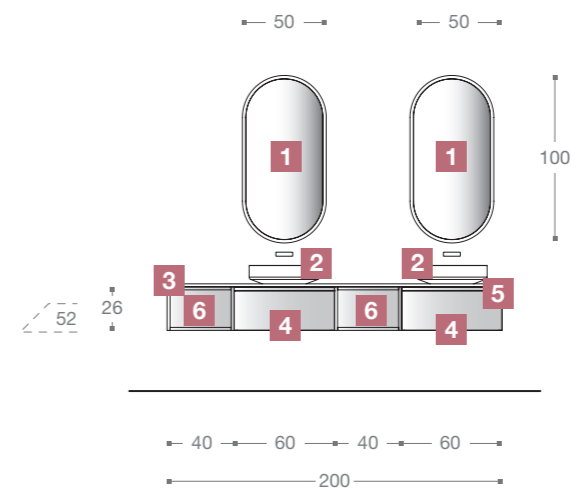

- 1** SHADE
- 2** IRIS - TENCOMAT - BIANCO OPACO  
*Blanc Mat / White Matt / Weiß Matt / Blanco Mate / Белый Матовый*
- 3** 934 NOCE BROWN
- 4** 934 NOCE BROWN
- 5** PRESA MANIGLIA  
*Prise De Main / Integrated Pull / Geöffnet Griffmulde / Tirador Integrado / Фрезер. ручка*
- 6** 413 AMBRA  
*Opaco / Mat / Matt / Matt / Mate / Матовый*



NORTH - TECNOMAT - 50x45x11

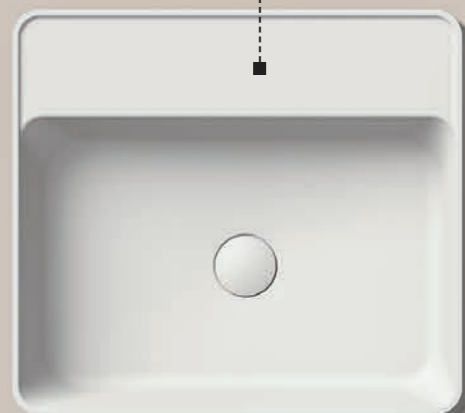

IRIS - TECNOMAT - 42x42x11

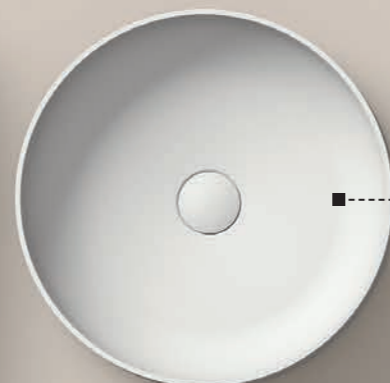

NIKO46 - CERAMICA - 46x33x13,5



SOFT - TECNOMAT - 58x36x14



DIAMOND - CERAMICA - 42x42x13



NIKO50 - CERAMICA - 49,5x39x14,5



JOY - TECNOMAT - 70x35x14



PLAZA - TECNOLITE / TECNOMOOD  
60x48x12

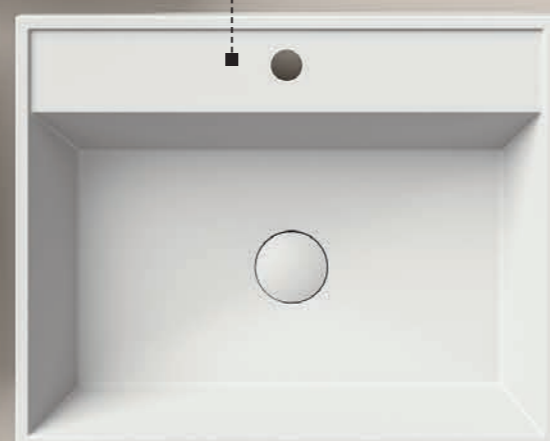

FRAME - TECNOMAT  
50x35x11

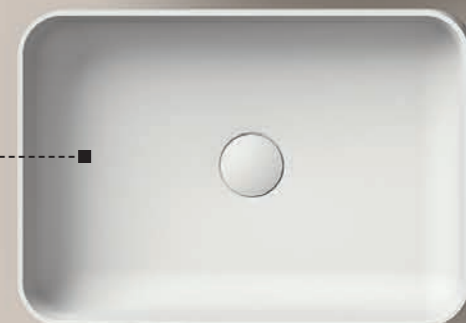

ART - CERAMICA - 42x42x13

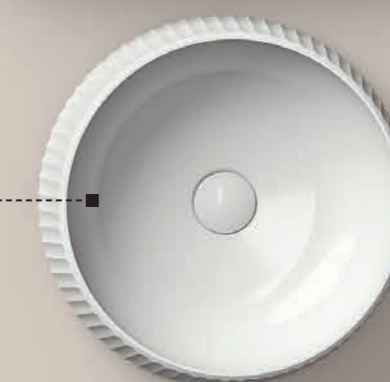

RAY - CERAMICA - 61x35x11,5







- 1** DOT

---

- 2** TECNOLITE - LB452 - 121

---

- 3** 939 RIGATO IMPERIALE

---

- 4** 408 MOKA  
*Opaco / Mat / Matt / Mate / Матовый*

---

- 5** PUSH PULL  
*Push-Pull / Push-To-Open / Push-To-Open / Push Pull / Push Pull*

---

- 6** 408 MOKA  
*Opaco / Mat / Matt / Mate / Матовый*

---

- 7** 939 RIGATO IMPERIALE

---

- 8** 939 RIGATO IMPERIALE

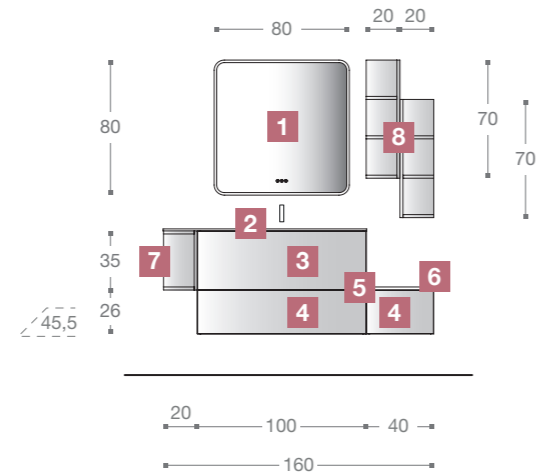

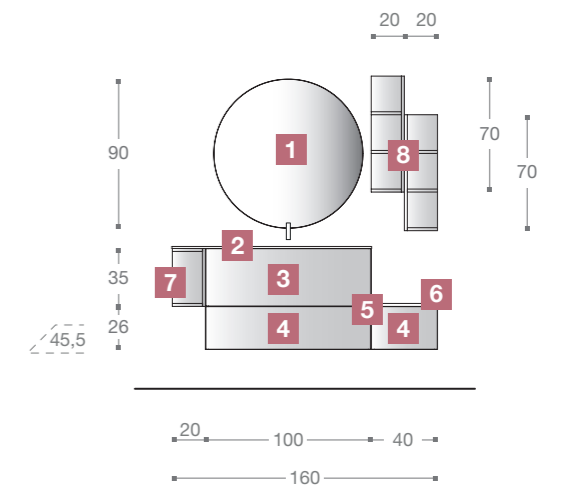

- 1 ERGO**

---

- 2 TECNOMOOD - LB452 - 408 MOKA**  
*Opaco / Mat / Matt / Matt / Mate / Матовый*

---

- 3 939 RIGATO IMPERIALE**

---

- 4 408 MOKA**  
*Opaco / Mat / Matt / Matt / Mate / Матовый*

---

- 5 PUSH PULL**  
*Push-Pull / Push-To-Open / Push-To-Open / Push Pull / Push Pull*

---

- 6 408 MOKA**  
*Opaco / Mat / Matt / Matt / Mate / Матовый*

---

- 7 939 RIGATO IMPERIALE**

---

- 8 939 RIGATO IMPERIALE**



**IT.** Pensili L.20 H.70 P.16 cm con un lato aperto e due ripiani, in essenza 939 Rigato Imperiale.

**FR.** Armoires L.20 H.70 P.16 cm avec un côté ouvert et 2 étagères, finition bois 939 Rigato Imperiale.

**EN.** Wall units W.20 H.70 D.16 cm with one open side and two shelves, in essenza 939 Rigato Imperiale.

**DE.** Hängeschränke B.20 H.70 T.16 cm mit einer offenen Seite und zwei Einlegeböden, in der Essenza 939 Rigato Imperiale.

**ES.** Armarios A.20 H.70 Ph16 cm con un lado abierto y dos repisas, en acabado madera 939 Rigato Imperiale.

**RU.** Шкафчики шир.20 выс.70 гл.16 см с одной открытой стороной и двумя полками в цвете 939 Rigato Imperiale.

**IT.** Base a giorno laterale H.35 L.20 P.45,5 cm con un lato aperto in essenza 939 Rigato Imperiale.

**FR.** Élément terminal à jour H.35 L.20 P.45 cm avec un côté ouvert en finition bois 939 Rigato Imperiale.

**EN.** Open side base H.35 W.20 D.45,5 cm with one open side in essenza 939 Rigato Imperiale.

**DE.** Seitlich offenes Element H.35 B.20 T.45,5 cm mit einer offenen Seite in Essenza 939 Rigato Imperiale.

**ES.** Módulo abierto lateral H.35 A.20 P.45,5 cm con un lado abierto en acabado madera 939 Rigato Imperiale.

**RU.** Открытая тумба выс.35 шир.20 гл.45,5 см в отделке под дерево 939 Rigato Imperiale.

- 1 KLIO

---

- 2 SPECCHIO FILO LUCIDO  
*Miroir simple / Simple mirror / Spiegel / Espejo canto pulido / Зеркало с полированными краями*

---

- 3 TECNOGRES - LV894 - 331 CALACATTA ORO

---

- 4 937 ROVERE ELEGANCE

---

- 5 PRESA MANIGLIA  
*Prise De Main / Integrated Pull / Geprüft / Griffmulde / Tirador Integrado / Фрезер. ручка*

---

- 6 937 ROVERE ELEGANCE

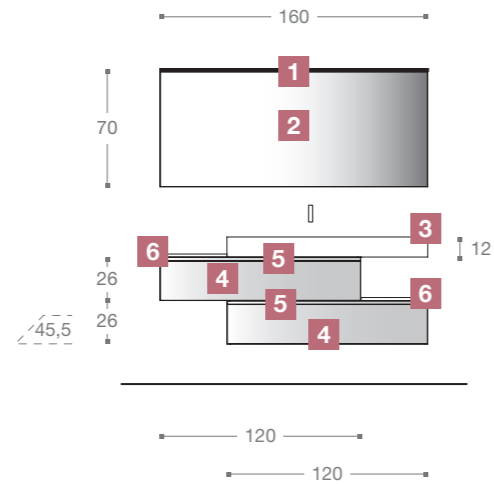

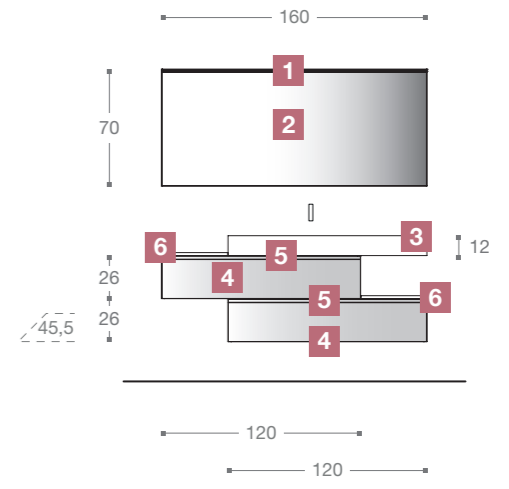

- 1** KLIO

---

- 2** **SPECCHIO FILO LUCIDO**  
Miroir simple / Simple mirror / Spiegel / Espejo  
canto pulido / Зеркало с полированными краями

---

- 3** TECNOMAT - VA020

---

- 4** 937 ROVERE ELEGANCE

---

- 5** **PRESA MANIGLIA**  
Prise De Main / Integrated Pull / Gefräser  
Griffmulde / Tirador Integrado / Фрезер. ручка

---

- 6** 937 ROVERE ELEGANCE



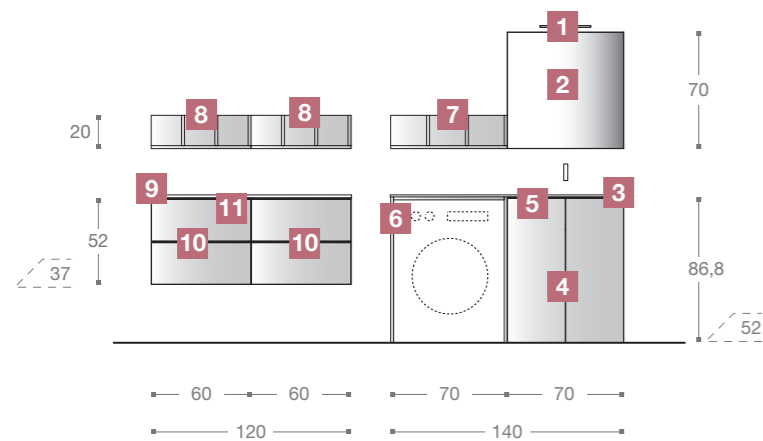

- 1 KUMA**

---

- 2 SPECCHIO FILO LUCIDO**  
*Miroir simple / Simple mirror / Spiegel / Espejo canto pulido / Зеркало с полированными краями*

---

- 3 TECNOLITE - LB608 - 121**

---

- 4 416 CRETA**  
*Opaco / Mat / Matt / Mate / Матовый*

---

- 5 G56 - 416 CRETA**  
*Opaco / Mat / Matt / Mate / Матовый*

---

- 6 416 CRETA**  
*Opaco / Mat / Matt / Mate / Матовый*

---

- 7 416 CRETA**  
*Opaco / Mat / Matt / Mate / Матовый*

---

- 8 416 CRETA**  
*Opaco / Mat / Matt / Mate / Матовый*

---

- 9 416 CRETA**  
*Opaco / Mat / Matt / Mate / Матовый*

---

- 10 416 CRETA**  
*Opaco / Mat / Matt / Mate / Матовый*

---

- 11 G56 - 416 CRETA**  
*Opaco / Mat / Matt / Mate / Матовый*





**IT.** Sopra dettaglio del top in Tecnolite finitura 121 bianco opaco con vasca integrata LB608 L. 50 cm, P. 31 cm.

**FR.** En haut détail du plan en Tecnolite finition 121 blanc mat avec vasque moulée LB608 L.50 cm, P.31 cm.

**EN.** Above detail of top in Tecnolite finish 121 matt white with integrated basin LB608 W. 50 cm, D. 31 cm.

**DE.** Oben Detail des Waschtisches in Tecnolite 121 matt weiß mit integriertem Waschbecken LB608 B. 50 cm, T. 31 cm.

**ES.** Arriba detalle de la encimera en Tecnolite acabado 121 blanco mate con cuba integrada LB608 A.50 cm, P.31 cm.

**RU.** Вверху деталь белого матового топа из Tecnolite 121 со встроенной раковиной LB608 шир.50 см гл.31 см.



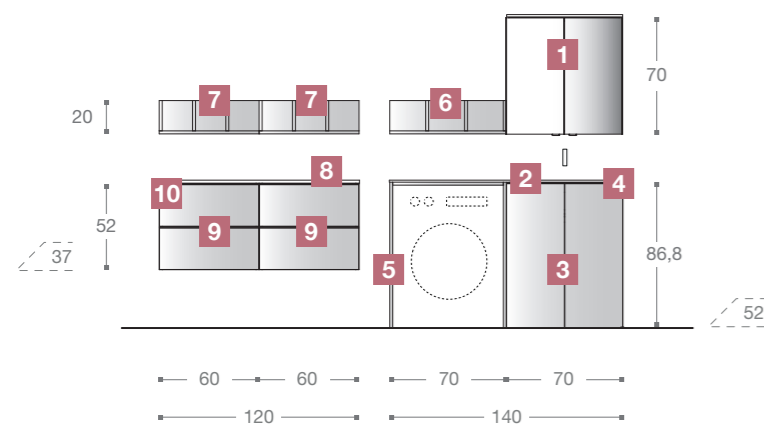

- 1** 416 CRETA  
Opaco / Mat / Matt / Mate / Матовый

---

- 2** TECNOLITE - LB608 - 121

---

- 3** 416 CRETA  
Opaco / Mat / Matt / Mate / Матовый

---

- 4** G56 - 416 CRETA  
Opaco / Mat / Matt / Mate / Матовый

---

- 5** 416 CRETA  
Opaco / Mat / Matt / Mate / Матовый

---

- 6** 416 CRETA  
Opaco / Mat / Matt / Mate / Матовый

---

- 7** 416 CRETA  
Opaco / Mat / Matt / Mate / Матовый

---

- 8** 416 CRETA  
Opaco / Mat / Matt / Mate / Матовый

---

- 9** 416 CRETA  
Opaco / Mat / Matt / Mate / Матовый

---

- 10** G56 - 416 CRETA  
Opaco / Mat / Matt / Mate / Матовый



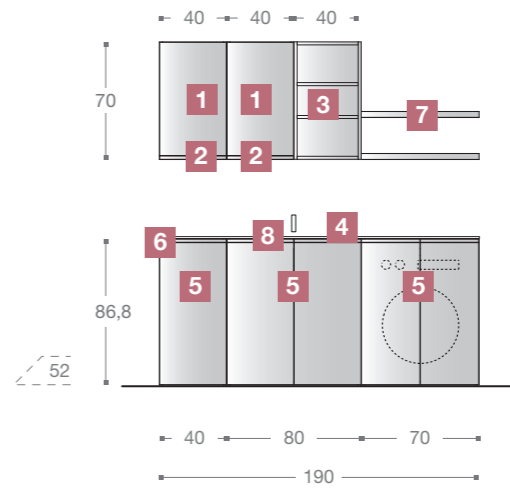

- 1** 936 ROVERE CLASSIC

---

- 2** PRESA MANIGLIA  
*Prise De Main / Integrated Pull / Gefräster Griffmulde / Tirador Integrado / Фрезер. ручка*

---

- 3** 936 ROVERE CLASSIC

---

- 4** TECNOMAT - LB505

---

- 5** 936 ROVERE CLASSIC

---

- 6** PRESA MANIGLIA  
*Prise De Main / Integrated Pull / Gefräster Griffmulde / Tirador Integrado / Фрезер. ручка*

---

- 7** SELECTA - 417 LATTE  
*Опало / Mat / Matt / Matt / Mate / Матовый*

---

- 8** TAVOLETTA - XC886  
*Planche A Laver / Washboard / Waschbrett / Tabla De Lavar / Стиральная Доска*



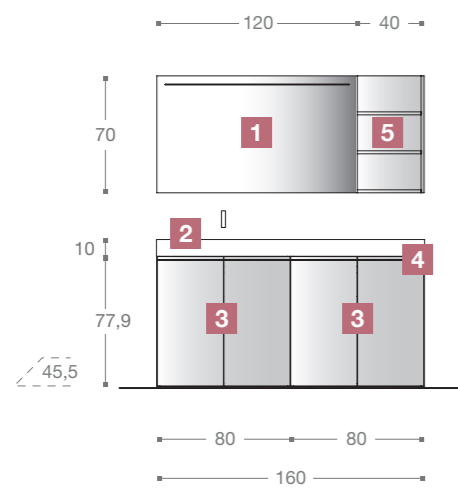

- 1** ESTRO

---

- 2** TECNOLAM - VA026 - 256 ROVERE PRUSSIA

---

- 3** 418 PONENTE  
*Opaco / Mat / Matt / Matt / Mate / Матовый*

---

- 4** PRESA MANIGLIA  
*Prise De Main / Integrated Pull / Geprägter Griffmulde / Tirador Integrado / Фрезер. ручка*

---

- 5** 418 PONENTE  
*Opaco / Mat / Matt / Matt / Mate / Матовый*





**IT.** Sopra dettaglio top scatolato in Tecnomat con vasca integrata VA026 L.50 P.27 cm, in finitura 256 Rovere Prussia. A fianco pensile a giorno con due ripiani, laccato opaco 418 Ponente.

**FR.** En haut détail du plan en Tecnomat avec vasque moulée VA026 L.50 P.27 cm, en HPL finition bois 256 Rovere Prussia. A côté armoire ajourée avec 2 étagères, laquée 418 Ponente mat.

**EN.** Above detail Tecnomat wall mounted top with integrated basin VA026 L.50 D.27 cm, in 256 Rovere Prussia finish. Beside open wall unit with two 418 Ponente matt lacquered shelves.

**DE.** Oben Detail Tecnomat freihängende Platte mit integriertem Waschbecken VA026 L.50 T.27 cm, in 256 Rovere Prussia Ausführung. Daneben offener Hängeschrank mit zwei matt lackierte 418 Ponente Einlegenböden.

**ES.** Arriba detalle encimera suspendida en Tecnomat con cuba integrada VA026 A.50 P.27 cm, en acabado 256 Rovere Prussia. Al lado armario abierto con dos repisas, lacado mate 418 Ponente.

**RU.** Вверху деталь высокого топа из Tecnomat со встроенной раковиной VA026 шир.50 гл.27 см в отделке под дерево 256 Rovere Prussia. Рядом открытый шкафчик с двумя полками в матовом лаке 418 Ponente.



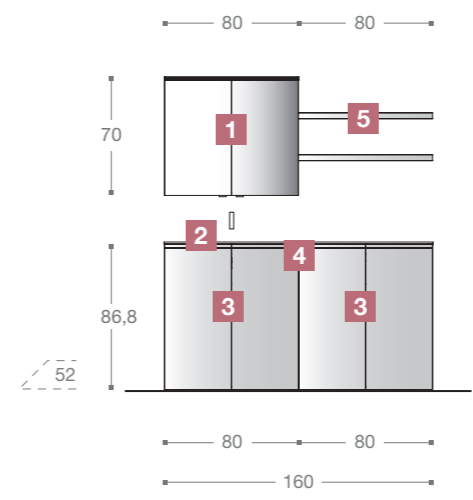

- 1** 418 PONENTE  
*Opaco / Mat / Matt / Matt / Mate / Матовый*

---

- 2** TEXTURIZZATO - VA031 - BIANCO  
*Blanc / White / Weiß / Blanco / Белый*

---

- 3** 418 PONENTE  
*Opaco / Mat / Matt / Matt / Mate / Матовый*

---

- 4** PRESA MANIGLIA  
*Prise De Main / Integrated Pull / GeFräster Griffmulde / Tirador Integrado / Фрезер. ручка*

---

- 5** SELECTA - 418 PONENTE  
*Opaco / Mat / Matt / Matt / Mate / Матовый*





- 1** GENESIS

---

- 2** TECNOGRES - LV944 - 317 MINE

---

- 3** 935 ROVERE TITANIO

---

- 4** PRESA MANIGLIA  
Prise De Main / Integrated Pull / Geöffnet  
Griffmulde / Tirador Integrado / Фрезер, ручка

---

- 5** 935 ROVERE TITANIO

---

- 6** SELECTA - 417 LATTE  
Opaco / Mat / Matt / Matt / Mate / Матовый

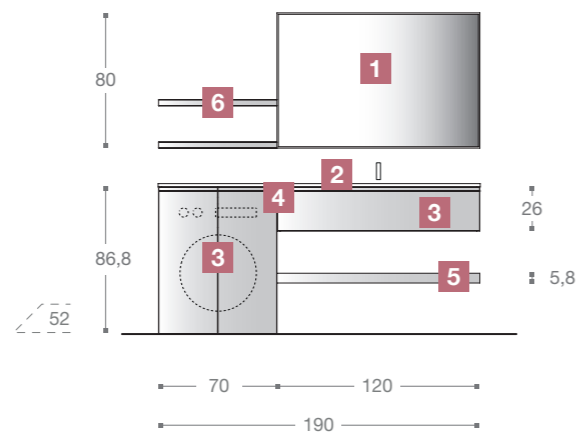

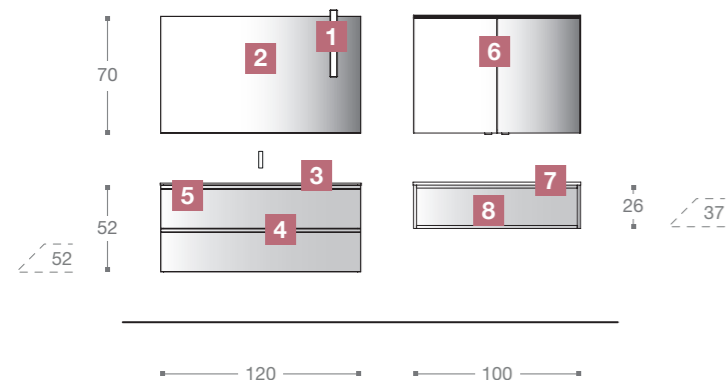
**1** CITY

**2** **SPECCHIO FILO LUCIDO**  
Miroir simple / Simple mirror / Spiegel / Espejo  
canto pulido / Зеркало с полированными краями

**3** **TEXTURIZZATO - VA030 - 404 METROPOLI**  
Opaco / Mat / Matt / Matt / Mate / Матовый

**4** **948 VINTAGE AVANA**

**5** **PRESA MANIGLIA**  
Prise De Main / Integrated Pull / Geöffnet  
Griffmulde / Tirador Integrado / Фрезер. ручка

**6** **404 METROPOLI**  
Opaco / Mat / Matt / Matt / Mate / Матовый

**7** **948 VINTAGE AVANA**

**8** **948 VINTAGE AVANA**





**IT.** A fianco particolari, della lampada City H.40 cm con luce Led e top Texturizzato con vasca VA030 L.50 e cover a colore, in finitura 404 Metropoli. Nella pagina seguente base a giorno con top H.1,8 in essenza 948 Vintage Avana e specchio contenitore con lampada incorporata.

**FR.** A côté les détails de la lampe City H40 cm avec lumière led et plan texturisé avec vasque VA030 L.50 cm en finition 404 Metropoli avec cache coordonné. A la page suivante élément bas à jour avec plan H.1,8 en finition bois 948 Vintage Avana et armoire miroir avec lampe intégrée.

**EN.** On the side details of the City H.40 cm lamp with Led light and Textured top with VA030 L.50 basin and cover in 404 Metropoli finish. On the following page open base unit with H.1.8 top in essenza 948 Vintage Avana and storage mirror with incorporated lamp.

**DE.** Auf der Seite Details der City Lampe H. 40 cm mit Led-Licht und strukturiertes Top mit VA030 L.50 Waschbecken und Farbabweckung, in 404 Metropoli Ausführung. Auf der folgenden Seite offenes Element mit H.1.8 Platte in essenza 948 Vintage Avana und Spiegelschrank mit eingebauter Lampe.

**ES.** Al lado particulares de la lámpara City H.40 cm con luz Led y encimera Texturizada con cuba VA030 A.50 y cover coloreada en acabado 404 Metropoli. En la página siguiente módulo abierto con encimera H.1,8 en acabado madera 948 Vintage Avana y armario espejo con lámpara integrada.

**RU.** Сбоку детали светильника City выс. 40 см со светодиодной подсветкой и текстурированного топа с раковиной VA030 шир.50 см и крышкой для донного клапана в цвете 404 Metropoli. На следующей странице открытая тумба с топом выс.1,8 см в отделке под дерево 948 Vintage Avana и зеркальный шкаф со встроенным светильником.





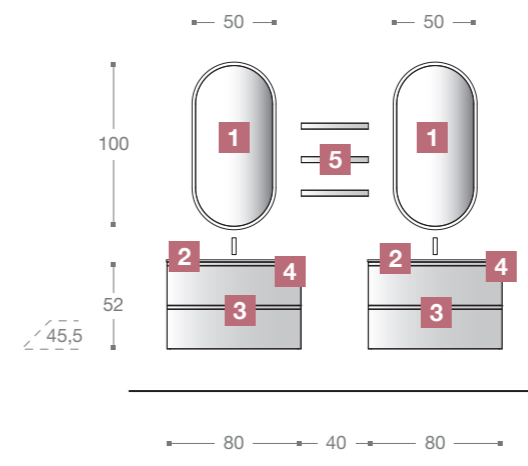

- 1** SHADE  
**CERAMICA - TK101**  
*Ceramique / Ceramic / Keramik / Cerámica / Керамика*
- 2** NERO OPACO  
*Noir Mat / Black Matt / Schwarz Matt / Negro Mate / Черный Матовый*
- 3** 934 NOCE BROWN
- 4** PRESA MANIGLIA  
*Prise De Main / Integrated Pull / Geöffnete Griffmulde / Tirador Integrado / Фрезер. ручка*
- 5** SELECTA - 433 NERO  
*Opaco / Mat / Matt / Matt / Mate / Матовый*

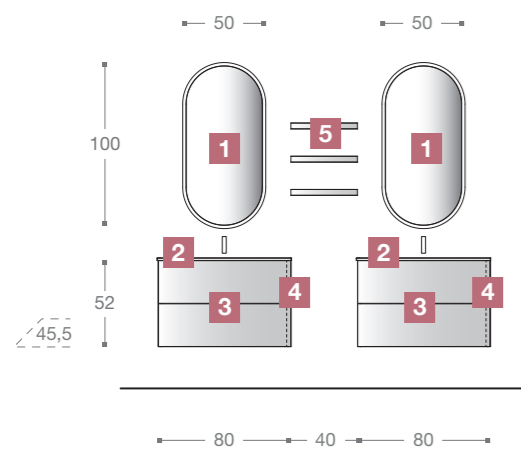

**1 SHADE**

**CERAMICA - TK101**

*Ceramique / Ceramic / Keramik / Cerámica /  
Керамика*

**2**

**NERO OPACO**

*Noir Mat / Black Matt / Schwarz Matt / Negro  
Mate / Черный Матовый*

**3**

**934 NOCE BROWN**

**4**

**G64 - NERO OPACO**

*Noir Mat / Black Matt / Schwarz Matt / Negro  
Mate / Черный Матовый*

**5**

**SELECTA - 433 NERO**

*Opaco / Mat / Matt / Matt / Mate / Матовый*





G56  
 B

G64  
 ● ●

**MANIGLIE**  
 PoignEes / Handles / Handgriffe / Tiradores / Ручки

G70.C - G70.V

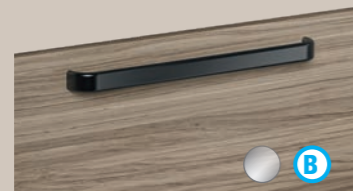

G01

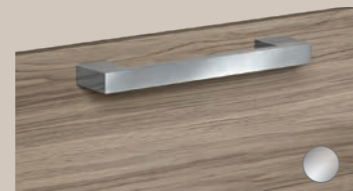

G59

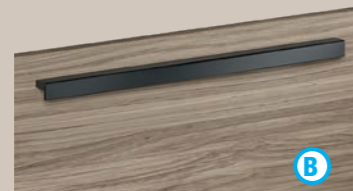

G54



**PRESA MANIGLIA**

Prise de main / Integrated pull / Gefräster griffmulde / Tirador Integrado / Фрезерованная ручка

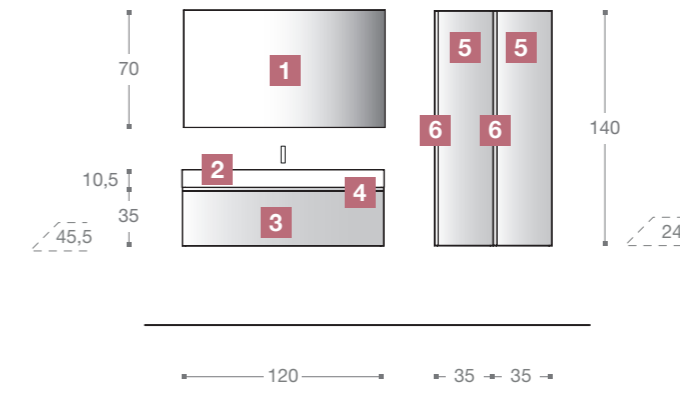

- 1** EDEN

---

- 2** TECNOMAT - TNB048

---

- 3** 935 ROVERE TITANIO

---

- 4** PRESA MANIGLIA  
*Prise De Main / Integrated Pull / Geprüftes Griffmulde / Tirador Integrado / Фрезер. ручка*

---

- 5** 935 ROVERE TITANIO

---

- 6** PRESA MANIGLIA  
*Prise De Main / Integrated Pull / Geprüftes Griffmulde / Tirador Integrado / Фрезер. ручка*



- 1** DOT

---

- 2** TECNOMAT - TNB049

---

- 3** 935 ROVERE TITANIO

---

- 4** G64 - BIANCO  
*Blanc / White / Weiß / Blanco / Белый*

---

- 5** 935 ROVERE TITANIO

---

- 6** G64 - BIANCO  
*Blanc / White / Weiß / Blanco / Белый*

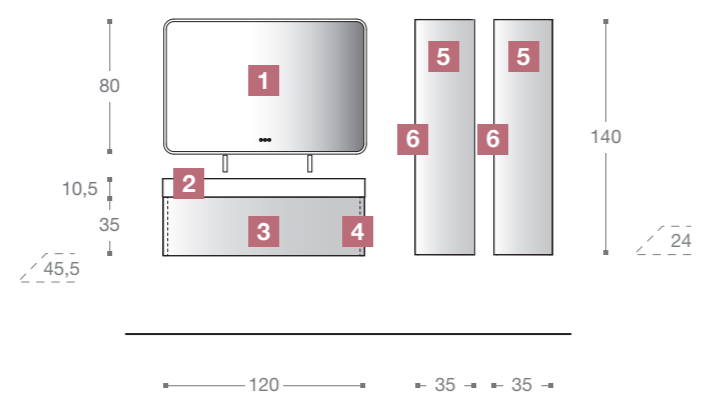

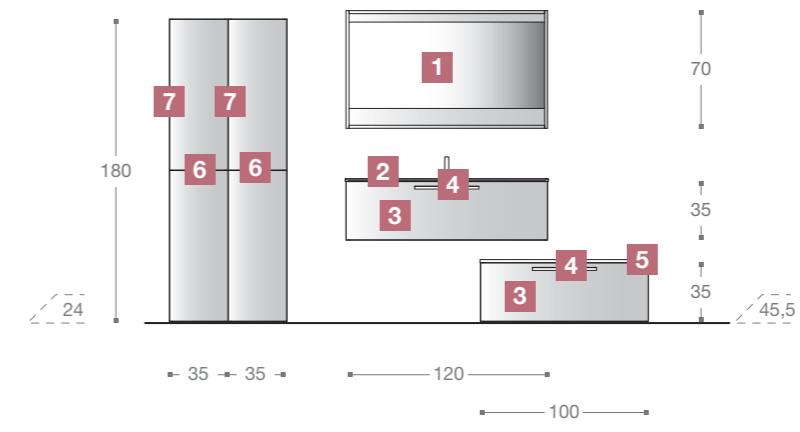

- 1 UNIKO - 960 NATIVO NATURALE**  
CERAMICA - TK103  
*Ceramique / Ceramic / Keramik / Cerámica / Керамика*
- 2 BIANCO OPACO**  
*Bianc Mat / White Matt / Weiß Matt / Blanco Mate / Белый Матовый*
- 3 960 NATIVO NATURALE**
- 4 G59 - 417 LATTE**  
*Opaco / Mat / Matt / Matt / Mate / Матовый*
- 5 960 NATIVO NATURALE**
- 6 417 LATTE**  
*Opaco / Mat / Matt / Matt / Mate / Матовые*
- 7 PUSH PULL**  
*Push-Pull / Push-To-Open / Push-To-Open / Push Pull / Push Pull*



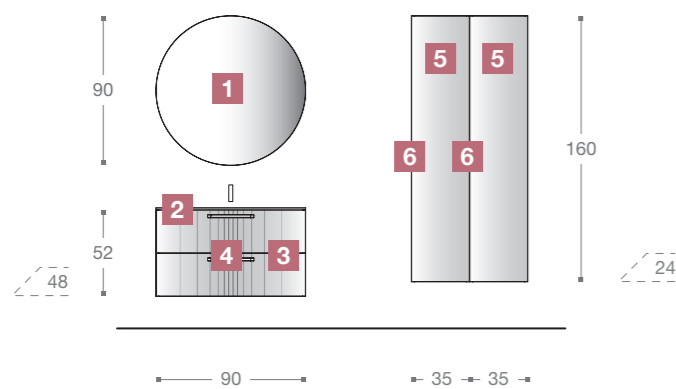

- 1 ERGO**
- 2 405 SABBIA - VA010 - VETRO SATINATO**  
Verre Satiné / Frosted Glass / Satiniert Glas / Cystal Satinado / Стекло матовое
- 3 405 SABBIA**  
Opaco / Mat / Matt / Matte / Матовый
- 4 G71.V - 405 SABBIA**  
Opaco / Mat / Matt / Matte / Матовый
- 5 405 SABBIA**  
Opaco / Mat / Matt / Matte / Матовый
- 6 PUSH PULL**  
Push-Pull / Push-To-Open / Push-To-Open / Push Pull / Push Pull





**IT.** Top in vetro satinato con vasca fusa in finitura 405 Sabbia.

**FR.** Plan en verre satiné avec vasque moulé en finition 405 Sabbia.

**EN.** Frosted glass top with integrated basin in 405 Sabbia finish.

**DE.** Platte aus satiniertem Glas mit integriertem Becken in der Ausführung 405 Sabbia.

**ES.** Encimera de cristal satinado con cuba fundida en acabado 405 Sabbia.

**RU.** Топ из матового стекла с интегрированной мойкой в цвете 405 Sabbia.

**IT.** Particolare della maniglia G71.V laccata opaco 405 Sabbia disponibile solo per basi con frontale curvo.

**FR.** Détail de la poignée G71.V laquée 405 Sabbia mat, disponible uniquement pour les éléments avec façade arrondie.

**EN.** Detail of the 405 Sabbia matt lacquered G71.V handle available only for base units with curved front.

**DE.** Detail des 405 Sabbia matt lackierten Griffs G71.V nur für Unterschränke mit gebogener Front erhältlich.

**ES.** Particular del tirador G71.V lacado mate 405 Sabbia disponible solo para módulos con frontal curvo.

**RU.** Деталь ручки G71.V в матовом лаке 405 Sabbia доступна только для тумб с изогнутым фасадом.



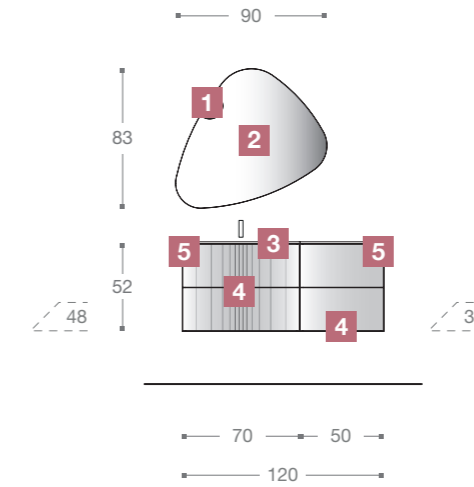

- 1 FOCUS**

---

- 2 RENÈ**

---

- 3 TECNOMOOD - LB203 - 415 SALVIA**  
*Opaco / Mat / Matt / Matt / Mate / Матовый*

---

- 4 415 SALVIA**  
*Opaco / Mat / Matt / Matt / Mate / Матовый*

---

- 5 PUSH PULL**  
*Push-Pull / Push-To-Open / Push-To-Open / Push Pull / Push Pull*



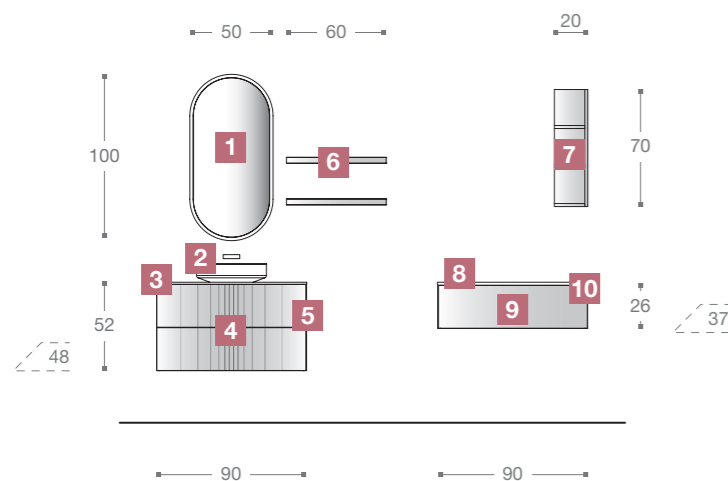

- 1 SHADE**

---

- 2 IRIS -TECNOMAT - 418 PONENTE**  
*Opaco / Mat / Matt / Matt / Mate / Матовый*

---

- 3 418 PONENTE - VETRO SATINATO**  
*Verre Satiné / Frosted Glass / Satiniert Glas / Cistal Satinado / Стекло матовое*

---

- 4 418 PONENTE**  
*Opaco / Mat / Matt / Matt / Mate / Матовый*

---

- 5 PUSH PULL**  
*Push-Pull / Push-To-Open / Push-To-Open / Push Pull / Push Pull*

---

- 6 SELECTA - 418 PONENTE**  
*Opaco / Mat / Matt / Matt / Mate / Матовый*

---

- 7 418 PONENTE**  
*Opaco / Mat / Matt / Matt / Mate / Матовый*

---

- 8 418 PONENTE**  
*Opaco / Mat / Matt / Matt / Mate / Матовый*

---

- 9 418 PONENTE**  
*Opaco / Mat / Matt / Matt / Mate / Матовый*

---

- 10 PUSH PULL**  
*Push-Pull / Push-To-Open / Push-To-Open / Push Pull / Push Pull*





**IT.** A sinistra dettaglio, della base L.90 H.26 P.37 cm con apertura push e del pensile a giorno, laccati opaco 418 Ponente. Nella pagina precedente particolare del lavabo sopra piano Iris di diametro 42 cm e altezza 11 cm in Tecnomat con finitura esterna 418 Ponente.

**FR.** A gauche détail de l'élément L.90 H.26 P.37 avec ouverture push-open et de l'armoire ajourée, laqués 418 Ponente mat. Dans la page précédente détail du lavabo à poser Iris avec un diamètre de 42 cm et une hauteur de 11 cm en Tecnomat, colorié extérieurement 418 Ponente mat.

**EN.** On the left detail of the L.90 H.26 D.37 cm base unit with push-pull opening and the open wall unit in 418 Ponente matt finish. On the previous page detail of the Iris countertop basin with a diameter of 42 cm and height of 11 cm in Tecnomat with 418 Ponente exterior finish.

**DE.** Links, Detail des Unterschrankes L.90 H.26 T.37 cm mit Push-Pull-Öffnung und des matt lackierten 418 Ponente offenen Hängeschrankes. Auf der vorherigen Seite Detail des Iris-Aufsatzwaschbeckens mit einem Durchmesser von 42 cm und einer Höhe von 11 cm aus Tecnomat mit Außenlackierung 418 Ponente.

**ES.** A la izquierda detalle del módulo A.90 H.26 P.37 cm con apertura push y del armario abierto, lacados mate 418 Ponente. En la página anterior particular del lavabo sobrecimera Iris de diámetro 42 cm y altura 11 cm en Tecnomat con acabado exterior 418 Ponente.

**RU.** Слева деталь тумбы шир.90 выс.26 гл.37 см с открытием push и открытый шкафчик в матовом лаке 418 Ponente. На предыдущей странице накладная раковина Iris диам. 42 см и выс. 11 см из белого Tecnomat с внешней отделкой 418 Ponente.

- 1** SHADE

---

- 2** IRIS-TECNOMAT - 418 PONENTE  
*Opaco / Mat / Matt / Mate / Матовый*

---

- 3** 418 PONENTE - VETRO SATINATO  
*Verre Satiné / Frosted Glass / Satiniert Glas / Cristal Satinado / Стекло матовое*

---

- 4** 418 PONENTE  
*Opaco / Mat / Matt / Mate / Матовый*

---

- 5** G71.C - CROMO  
*Chrome / Chrome / Verchromt / Cromo / Хром*

---

- 6** SELECTA - 418 PONENTE  
*Opaco / Mat / Matt / Mate / Матовый*

---

- 7** 418 PONENTE  
*Opaco / Mat / Matt / Mate / Матовый*

---

- 8** 418 PONENTE  
*Opaco / Mat / Matt / Mate / Матовый*

---

- 9** 418 PONENTE  
*Opaco / Mat / Matt / Mate / Матовый*

---

- 10** PUSH PULL  
*Push-Pull / Push-To-Open / Push-To-Open / Push Pull / Push Pull*

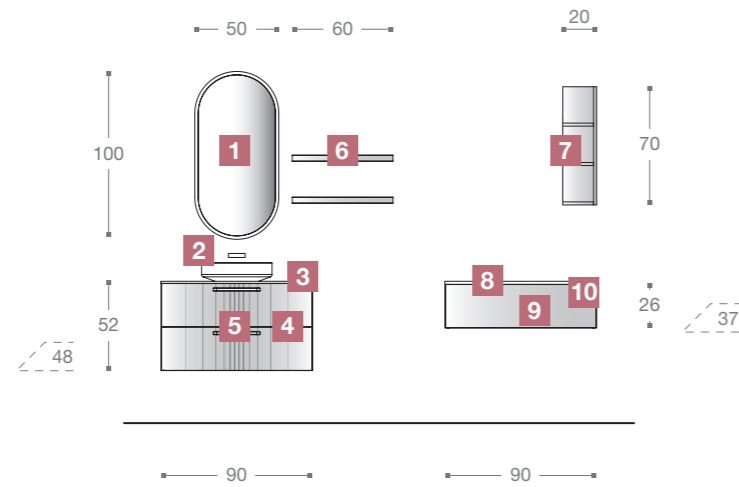

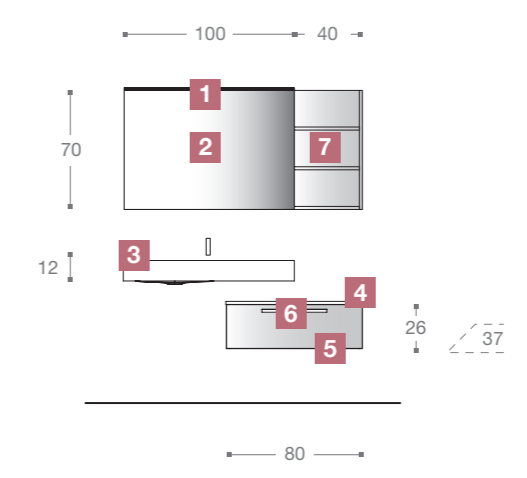

- 1** SLIM - H58.1000

---

- 2** SPECCHIO FILO LUCIDO  
*Miroir simple / Simple mirror / Spiegel / Espejo canto pulido / Зеркало с полированными краями*

---

- 3** TECNOMOOD - LB177 - 404 METROPOLI  
*Opaco / Mat / Matt / Matt / Mate / Матовый*

---

- 4** 935 ROVERE TITANIO

---

- 5** 935 ROVERE TITANIO

---

- 6** G59 - 404 METROPOLI  
*Opaco / Mat / Matt / Matt / Mate / Матовый*

---

- 7** 935 ROVERE TITANIO

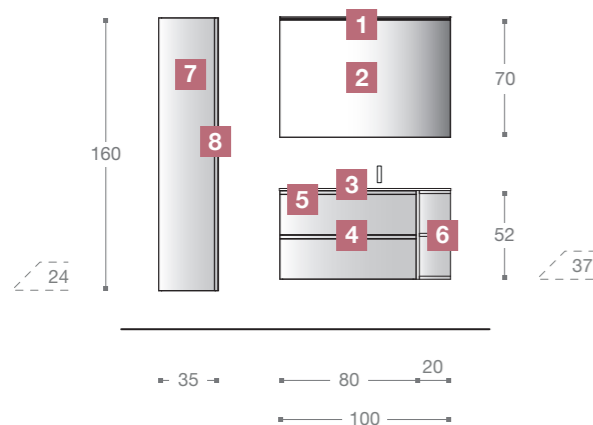

**1 KLIO**

**2 SPECCHIO FILO LUCIDO**  
Miroir simple / Simple mirror / Spiegel / Espejo  
canto pulido / Зеркало с полированными краями

**3 TECNOMOOD - LB177 - 418 PONENTE**  
Opaco / Mat / Matt / Матовый

**4 418 PONENTE**  
Opaco / Mat / Matt / Матовый

**5 PRESA MANIGLIA**  
Prise De Main / Integrated Pull / Gepräster  
Griffmulde / Tirador Integrado / Фрезер. ручка

**6 418 PONENTE**  
Opaco / Mat / Matt / Матовый

**7 418 PONENTE**  
Opaco / Mat / Matt / Матовый

**8 PRESA MANIGLIA**  
Prise De Main / Integrated Pull / Gepräster  
Griffmulde / Tirador Integrado / Фрезер. ручка



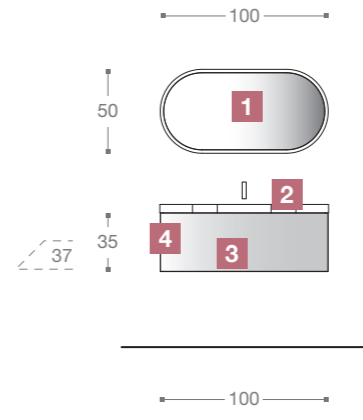

- 1** SHADE

---

- 2** TECNOLITE - LB294 - 121

---

- 3** 961 NATIVO COTTO

---

- 4** **PUSH PULL**  
Push-Pull / Push-To-Open / Push-To-Open /  
Push Pull / Push Pull



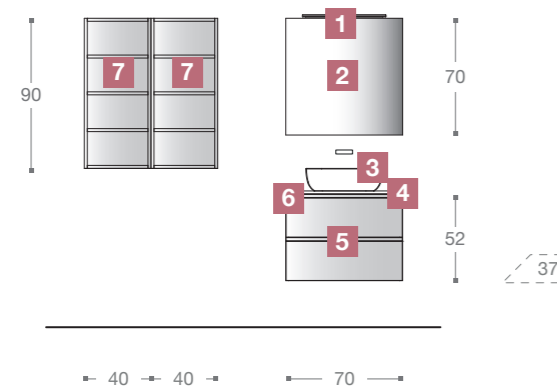

- 1** **SURA 500 - BIANCO**  
*Blanc / White / Weiß / Blanco / Белый*

---

- 2** **SPECCHIO FILO LUCIDO**  
*Miroir simple / Simple mirror / Spiegel / Espejo  
santo pulido / Зеркало с полированными краями*

---

- 3** **NIKO - CERAMICA**  
*Ceramique / Ceramic / Keramik / Cerámica /  
Керамика*

---

- 4** **BIANCO LUCIDO**  
*Blanc Brillant / White Glossy / Weiss  
Höchglanz / Blanco Brillo / Белый Глянцевый*

---

- 5** **948 VINTAGE AVANA**

---

- 6** **PRESA MANIGLIA**  
*Prise De Main / Integrated Pull / Geprüster  
Griffmulde / Tirador Integrado / Фрезер. ручка*

---

- 7** **948 VINTAGE AVANA**





**PORTALAVABI**

Meubles sous-vasque / Wash-basin base units / Waschtischunterschranke / Portalavabos / Тумбы под раковину

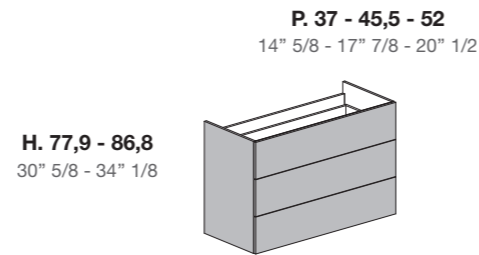
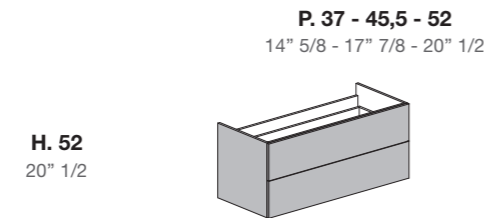
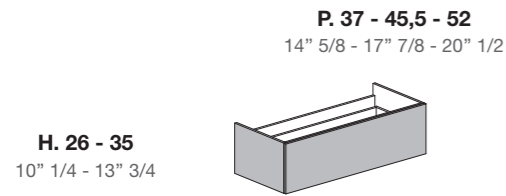

**L. 60 - 70 - 80 - 90 - 100 - 120**  
23" 1/2 - 27" 1/2 - 31" 1/2 - 35" 1/2 - 39" 3/8 - 47" 1/4

**L. 60 - 70 - 80 - 90 - 100 - 120**  
23" 1/2 - 27" 1/2 - 31" 1/2 - 35" 1/2 - 39" 3/8 - 47" 1/4

**L. 60 - 70 - 80 - 90 - 100 - 120**  
23" 1/2 - 27" 1/2 - 31" 1/2 - 35" 1/2 - 39" 3/8 - 47" 1/4

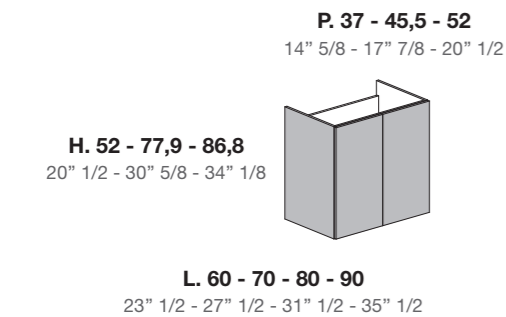

**BASI**

Éléments bas / Base units / Unterschranke / Módulos / Тумбы

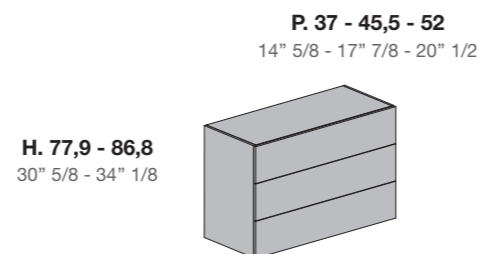
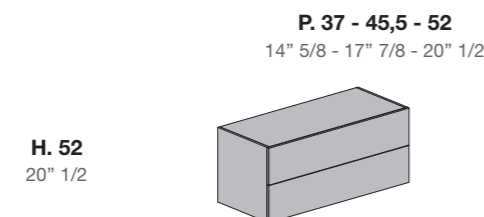
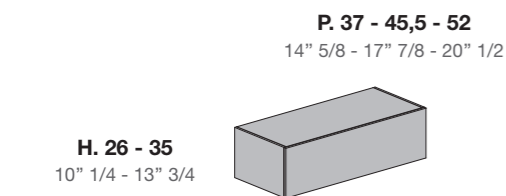

**L. 40 - 50 - 60 - 70 - 80 - 90 - 100 - 120**  
15" 3/4 - 19" 1/2 - 23" 1/2 - 27" 1/2 - 31" 1/2 - 35" 1/2 - 39" 3/8 - 47" 1/4

**L. 40 - 50 - 60 - 70 - 80 - 90 - 100 - 120**  
15" 3/4 - 19" 1/2 - 23" 1/2 - 27" 1/2 - 31" 1/2 - 35" 1/2 - 39" 3/8 - 47" 1/4

**L. 40 - 50 - 60 - 70 - 80 - 90 - 100 - 120**  
15" 3/4 - 19" 1/2 - 23" 1/2 - 27" 1/2 - 31" 1/2 - 35" 1/2 - 39" 3/8 - 47" 1/4

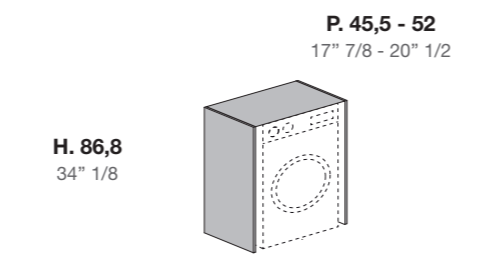
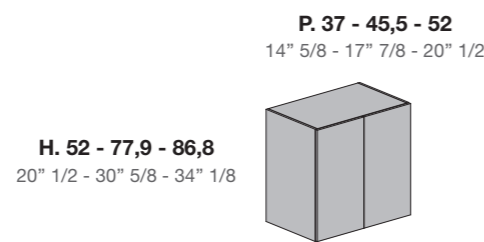
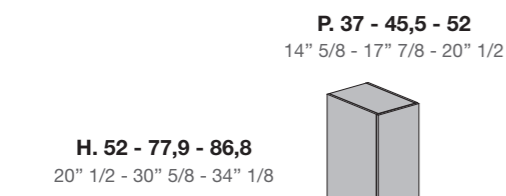

**L. 40**  
15" 3/4

**L. 50 - 60 - 70 - 80 - 90**  
19" 1/2 - 23" 1/2 - 27" 1/2 - 31" 1/2 - 35" 1/2

**L. 70**  
27" 1/2

**PORTALAVABI**

Meubles sous-vasque / Wash-basin base units / Waschtischunterschranke / Portalavabos / Тумбы под раковину

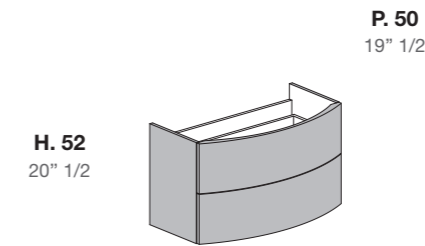
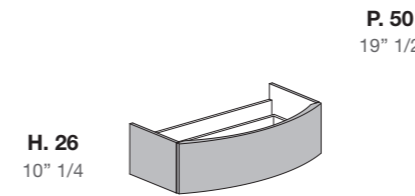

**L. 70 - 90**  
27" 1/2 - 35" 1/2

**L. 70 - 90**  
27" 1/2 - 35" 1/2

**COLORI LACCATI OPACI E LUCIDI**

Couleurs mates et brillantes / Matt and glossy colours / Matt und glänzende lackierte Farben / Colores mates y brillos / Матов. и глянец. цвета

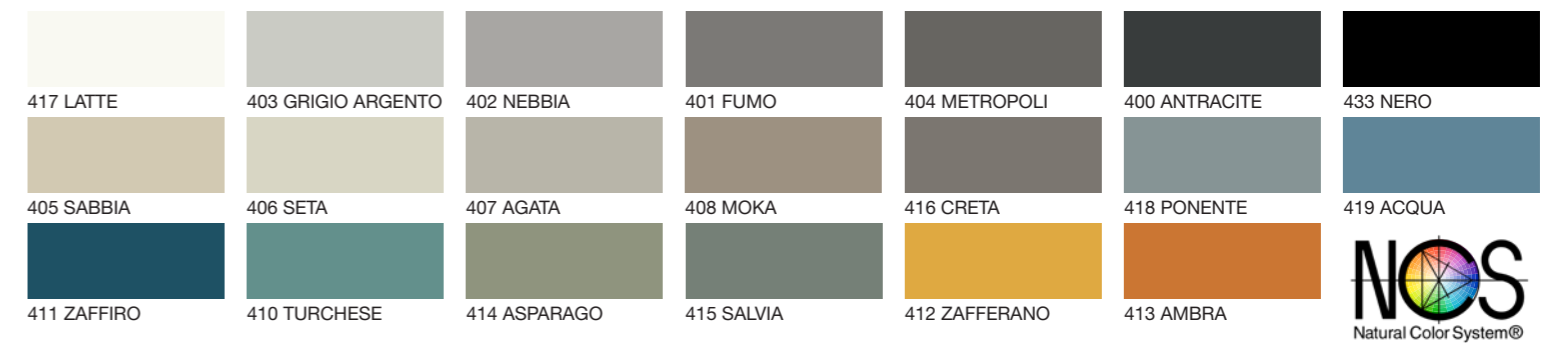

**ESSENZE**

Finition bois / Wood finishes / Holzoptik / Acabados madera / Отделки под дерево



**TECNOLAM - COLORI FENIX'**

Tecnolam - Couleurs / Tecnolam - Colours / Tecnolam - Farben / Tecnolam - Colores / Tecnolam - Цвета

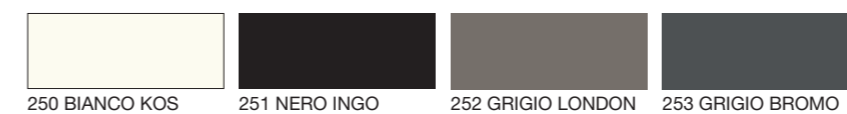

**TECNOLAM - FINITURE HPL**

Tecnolam - Finitions HPL / Tecnolam - HPL Finishes / Tecnolam - HPL Ausführungen / Tecnolam - Acabados HPL / Tecnolam - Отделки HPL





## ■ ONDA

**IT.** Il concept Onda trova nella morbidezza della linea curva il suo segno distintivo.  
Un mobile bagno monoblocco capace di creare un nuovo equilibrio nella stanza da bagno.

**FR.** La collection Onda trouve sa signature d'auteur dans la douceur de la ligne courbe.  
Un meuble capable de créer un nouvel équilibre dans la salle de bain.

**EN.** The Onda concept finds its distinctive mark in the softness of the curved line.  
A one-piece bathroom furniture unit capable of creating a new balance in the bathroom.

**DE.** Das Konzept Onda zeichnet sich durch die Weichheit der geschwungenen Linie aus.  
Ein einteiliges Badmöbel, das ein neues Gleichgewicht im Bad schafft.

**ES.** El prototipo Onda encuentra en la suavidad de la línea curva su rasgo distintivo.  
Un monobloque capaz de crear un nuevo equilibrio en el cuarto de baño.

**RU.** Отличительной особенностью концепции Onda является мягкость изогнутых линий. Моноблочная мебель для ванной комнаты способна создать новый баланс в ванной комнате.

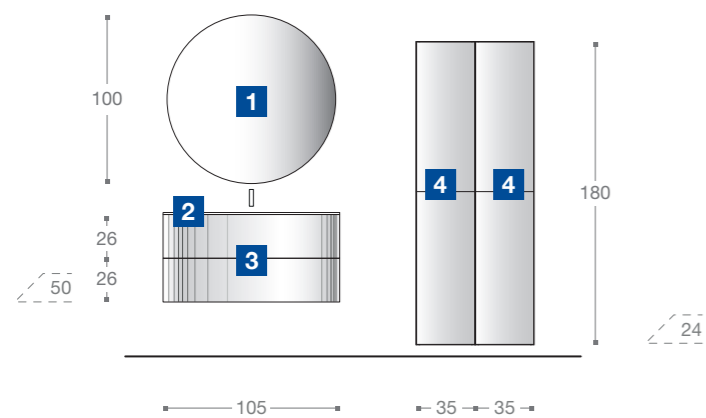

- 1** ERGO

---

- 2** TECNOPLAN - TK052

---

- 3** 411 ZAFFIRO  
*Lucido / Brillant / Glossy / Hochglanz / Brillo / Глянцевый*

---

- 4** 411 ZAFFIRO  
*Lucido / Brillant / Glossy / Hochglanz / Brillo / Глянцевый*





**IT.** Accanto proposta della base monoblocco laccata lucido 411 Zaffiro con maniglia G26 finitura bianco. Nella pagina precedente dettaglio del top in Tecnoplan bianco lucido e base monoblocco laccata lucido 411 Zaffiro, apertura push-pull.

**FR.** A côté l'élément bas laqué 411 Zaffiro brillant avec poignée G26 finition blanche. Dans la page précédente détail du plan en Tecnoplan blanc brillant et élément bas laqué 411 Zaffiro brillant, ouverture push-open.

**EN.** On the opposite page proposal of the glossy lacquered 411 Zaffiro monoblock base unit with G26 handle in white finish. On the previous page detail of the glossy white Tecnoplan top and glossy lacquered 411 Zaffiro monoblock base unit, push-pull opening.

**DE.** Auf der gegenüberliegenden Seite: Vorschlag für den glänzend lackierten 411 Zaffiro Monoblock-Unterschrank mit weißem Griff G26. Auf der vorhergehenden Seite: Detail des glänzend weißen Tecnoplan-Waschtisch und des glänzend lackierten 411 Zaffiro Monoblock-Unterschrankes, Push-Pull-Öffnung.

**ES.** Al lado propuesta del monobloque lacado 411 Zaffiro con tirador G26 acabado blanco. En la página anterior detalle de la encimera en Tecnoplan blanco brillo y monobloque lacado brillo 411 zaffiro, apertura push-pull.

**RU.** Сбоку вариант моноблока в глянцево лаке 411 Zaffiro и ручкой G26 белого цвета. На предыдущей странице деталь белого глянцевого топа из Tecnoplan и моноблока в глянцево лаке 411 Zaffiro с открытием push-pull.

- 1** KLIO - H64.900

---

- 2** SPECCHIO FILO LUCIDO  
*Miroir simple / Simple mirror / Spiegel / Espejo canto pulido / Зеркало с полированными краями*

---

- 3** TECNOMAT - TK049

---

- 4** 417 LATTE  
*Opaco / Mat / Matt / Matt / Mate / Матовый*

---

- 5** 418 PONENTE  
*Opaco / Mat / Matt / Matt / Mate / Матовый*

---

- 6** 418 PONENTE  
*Opaco / Mat / Matt / Matt / Mate / Матовый*

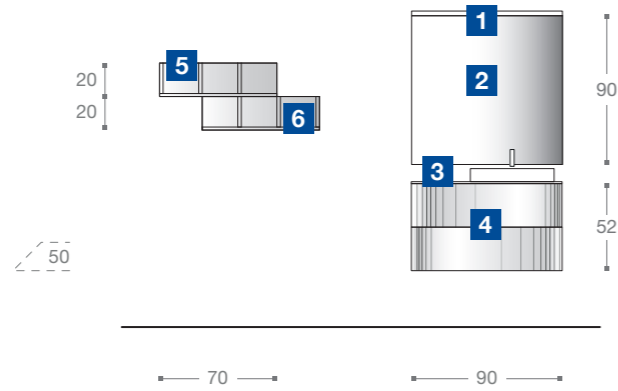

- 1** SHADE

---

- 2** TECNOMAT - TK046

---

- 3** 407 AGATA  
*Opaco / Mat / Matt / Mate / Матовый*

---

- 4** 408 SETA  
*Opaco / Mat / Matt / Mate / Матовый*

---

- 5** 407 AGATA  
*Opaco / Mat / Matt / Mate / Матовый*

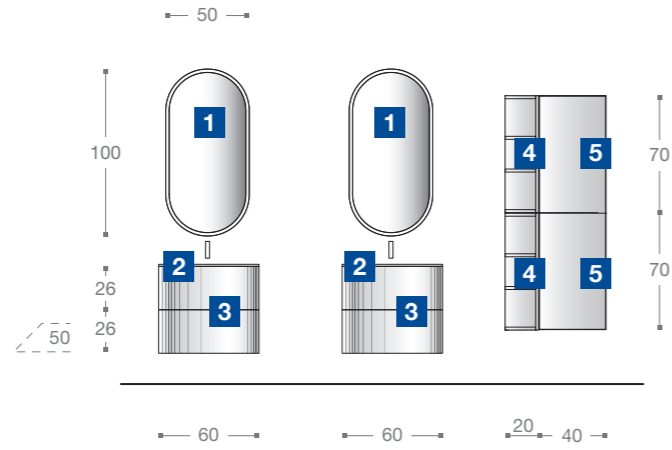

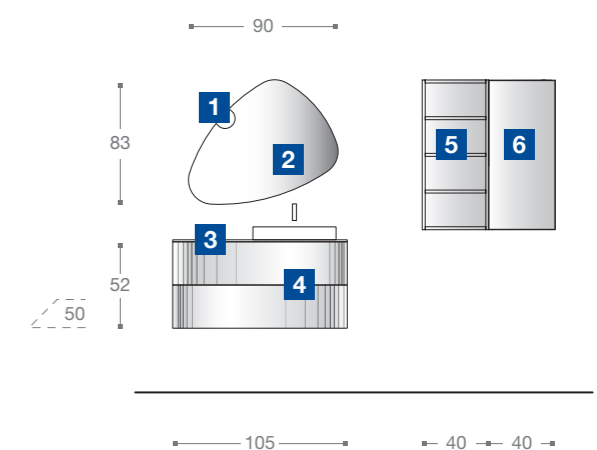

- 1** FOCUS

---

- 2** RENÈ

---

- 3** TECNOMAT - TK045

---

- 4** 414 ASPARAGO  
*Opaco / Mat / Matt / Mate / Матовый*

---

- 5** 417 LATTE  
*Opaco / Mat / Matt / Mate / Матовый*

---

- 6** 414 ASPARAGO  
*Opaco / Mat / Matt / Mate / Матовый*



**IT.** Sopra particolare del top in Tecnomat finitura bianco opaco. Nella pagina a fianco dettaglio della maniglia G25 in finitura bianco opaco.

**FR.** En haut détail du plan en Tecnomat finition blanc mat. Dans la page suivante détail de la poignée G25 en finition blanc mat.

**EN.** Above detail of the Tecnomat top in matt white finish. On the opposite page detail of the G25 handle in matt white finish.

**DE.** Oben: Detail der Tecnomat-Platte in mattweißer Ausführung. Gegenüberliegende Seite: Detail des G25-Griffs in mattweißer Ausführung.

**ES.** Arriba particular de la encimera en Tecnomat acabado blanco mate. En la página al lado detalle del tirador G25 en acabado blanco mate.

**RU.** Вверху деталь топа из белого матового Tecnomat. На противоположной странице деталь ручки G25 в белой матовой отделке.





- 1** ERGO

---

- 2** TECNOMAT - TK048

---

- 3** 413 AMBRA  
*Opaco / Mat / Matt / Mate / Матовый*

---

- 4** 413 AMBRA  
*Opaco / Mat / Matt / Mate / Матовый*

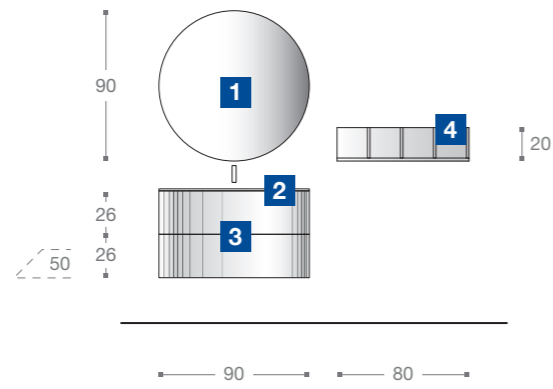

**MONOBLOCCHI**

*Meubles sous-vasque / Wash-basin units / Waschtischunterschranke / Monobloques / Моноблоки*

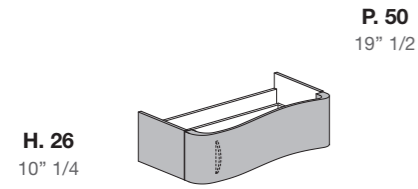

H. 26  
10" 1/4

P. 50  
19" 1/2

**L. 60 - 90 - 105**  
23" 1/2 - 35" 1/2 - 41" 3/8

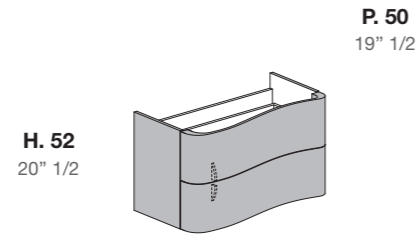

H. 52  
20" 1/2

P. 50  
19" 1/2

**L. 60 - 90 - 105**  
23" 1/2 - 35" 1/2 - 41" 3/8

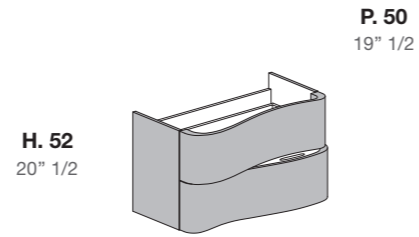

H. 52  
20" 1/2

P. 50  
19" 1/2

**L. 60 - 90 - 105**  
23" 1/2 - 35" 1/2 - 41" 3/8

TECHNICAL DATA

**COLORI LACCATI OPACHI E LUCIDI**

*Couleurs mates et brillantes / Matt and glossy colours / Matt und glänzende lackierte Farben / Colores mates y brillos / Матов. и глянцев. цвета*

417 LATTE	403 GRIGIO ARGENTO	402 NEBBIA	401 FUMO	404 METROPOLI	400 ANTRACITE	433 NERO
405 SABBIA	406 SETA	407 AGATA	408 MOKA	416 CRETA	418 PONENTE	419 ACQUA
411 ZAFFIRO	410 TURCHESE	414 ASPARAGO	415 SALVIA	412 ZAFFERANO	413 AMBRA	NOS Natural Color System®



## ■ COMPACT

**IT.** Una gamma di prodotti di piccole dimensioni, compatti e perfetti nei volumi scavati. Una nuova visione estetica in uno spazio ridotto.

**FR.** Une gamme de produits de petites dimensions, compactes et parfaits dans les volumes. Une nouvelle vision esthétique dans un espace réduit.

**EN.** A range of products of small dimension, compact and perfect in their hollow volumes. A new aesthetic vision in a small space.

**DE.** Eine Reihe von kleinen Produkten, kompakt und perfekt in hohlen Volumen. Eine neue ästhetische Vision auf kleinem Raum.

**ES.** Una gama de productos de pequeños tamaños, compactos y perfectos en los volúmenes excavados. Una nueva visión estética en un espacio reducido.

**RU.** Ассортимент небольших, компактных и совершенных в своих полых объемах изделий. Новое эстетическое видение в небольшом пространстве.

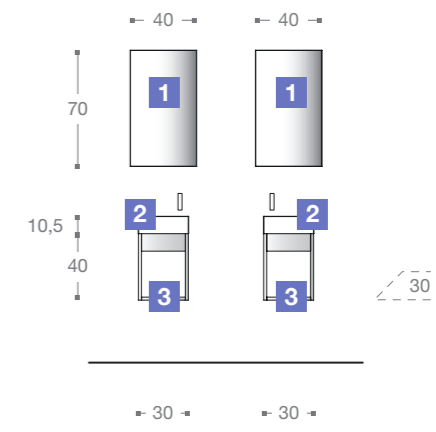

- 1** EDEN

---

- 2** TECNOMAT - TNB038

---

- 3** 413 AMBRA  
*Opaco / Mat / Matt / Matt / Mate / Матовый*



**IT.** Lavabo quadrato L.30 P.30 H.10,5 cm in Tecnomat bianco opaco con piano d'appoggio per miscelatore.

**FR.** Lavabo carré L.30 P.30 H.10,5 en Tecnomat blanc mat avec plage pour robinet.

**EN.** Square washbasin W.30 D.30 H.10,5 cm in Tecnomat matt white with countertop for mixer.

**DE.** Quadratisches Waschbecken B.30 T.30 H.10,5 cm in Tecnomat matt weiß mit Ablagefläche für Mischer.

**ES.** Lavabo cuadrado A.30 P.30 H.10,5 cm en Tecnomat blanco mate con plano en apoyo para el grifo.

**RU.** Квадратная раковина шир.30 гл.30 выс.10,5 см из белого матового Tecnomat с опорной поверхностью для смесителя.

**IT.** Variante del lavamani L.30 P.30 H.40 cm con vano a giorno in essenza 935 Rovere Titanio.

**FR.** Variante du meuble lave-mains L.30 P.30 H.40 cm avec élément ajouré en finition bois 935 Rovere Titanio.

**EN.** Compact unit variant W.30 D.30 H.40 cm with open compartment in essenza 935 Rovere Titanio.

**DE.** Gästewaschbecken Variante B.30 T.30 H.40 cm mit offenem Fach in Essenza 935 Rovere Titanio.

**ES.** Variante lavamanos A.30 P.30 H.40 cm con compartimento abierto en acabado madera 935 Rovere Titanio.

**RU.** Вариант раковины шир.30 гл.30 выс.40 см с открытым отделением в отделке под дерево 935 Rovere Titanio.

COMPACT

LAVAMANI  
Lave-mains / Compact unit / Gästewaschbecken / Lavamanos / Рукомойники

LAVAMANI  
Lave-mains / Compact unit / Gästewaschbecken / Lavamanos / Рукомойники

COMPACT





- 1** NOBI

---

- 2** TECNOMAT - TNB039

---

- 3** 937 ROVERE ELEGANCE

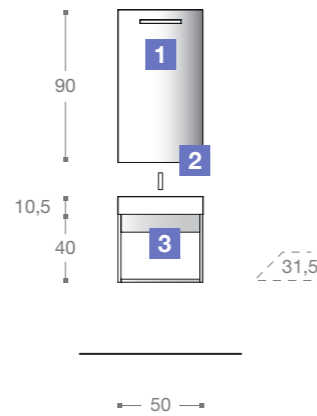



**IT.** Proposta della composizione precedente con top in Tecnomat L.50 P.32 H.10,5 cm e lavamani con vano a giorno laccato opaco 407 Agata.

**FR.** Version de l'ensemble précédent avec plan en Tecnomat L.50 P.32 H.10,5 cm et meuble ajouré laqué 407 Agata mat.

**EN.** Proposal of the previous composition with Tecnomat top W.50 D.32 H.10,5 cm and compact unit with matt lacquered 407 Agata open unit.

**DE.** Vorschlag der vorherigen Komposition mit Tecnomat Platte B.50 T.32 H.10,5 cm und Gästewaschbecken mit matt lackiertem 407 Agata offenem Fach

**ES.** Propuesta de la composición anterior con encimera en Tecnomat A.50 P.32 H.10,5 cm y lavamanos con compartimento abierto lacado mate 407 Agata.

**RU.** Предложение предыдущей композиции с топом из Tecnomat шир.50 гл.32 выс.10,5 см в матовом лаке 407 Agata.



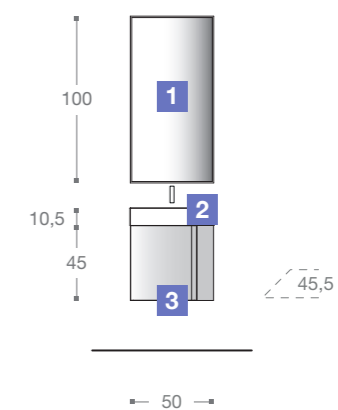

- 1 GENESIS
- 2 TECNOMAT - TNB040
- 3 948 VINTAGE AVANA



**IT.** A fianco dettaglio del lavabo in Tecnomat, L.50 P.46 H.10,5 cm bianco opaco con piano d'appoggio per miscelatore, sopra particolare presa maniglia del lavamani con anta aperta in essenza 948 Vintage Avana. Nella pagina seguente proposta del lavamani con vano a giorno laterale laccato opaco 414 Asparago.

**FR.** A côté détail du plan en Tecnomat, L.50 P.46 H.10,5 cm blanc mat avec plage pour robinet; en haut détail de la prise de mains du meuble avec porte ouverte en finition bois 948 Vintage Avana. Dans la page suivante, version du meuble lave-mains avec élément ajouré sur le côté laqué 414 Asparago mat.

**EN.** To the side detail of the Tecnomat washbasin, W.50 D.46 H.10,5 cm matt white with support surface for mixer; above detail of the integrated pull of the compact unit with open door in essence 948 Vintage Avana. On the following page proposal of the washbasin with open side unit in 414 Asparago matt.

**DE.** Seitlich Detail des Tecnomat-Waschtischs, B.50 T.46 H.10,5 cm matt weiß mit Ablagefläche für Armatur; oben Detail des Griffs des Gästewaschbeckens mit offener Tür in essence 948 Vintage Avana. Auf der folgenden Seite Vorschlag für den Gästewaschbecken mit matt lackiertem 414 Asparago offenem Seitenfach.

**ES.** Al lado detalle del lavabo en Tecnomat, A.50 P.46 H.10,5 cm blanco mate con plano en apoyo para el grifo, arriba particular tirador integrado del lavamanos con puerta abierta en acabado madera 948 Vintage Avana. En la página siguiente propuesta del lavamanos con compartimiento abierto lateral lacado mate 414 Asparago.

**RU.** Сбоку деталь топа из белого матового Tecnomat шир.50 гл.46 выс.10,5 см с опорной поверхностью для смесителя, сверху деталь фрезерованной ручки с открытой дверцей в отделке под дерево 948 Vintage Havana. На следующей странице раковина с открытым боковым отделением в матовом лаке 414 Asparago.



04 COMPACT

- 1 EDEN
- 2 TECNOPLAN - TK043
- 3 967 ROVERE CAFFÈ

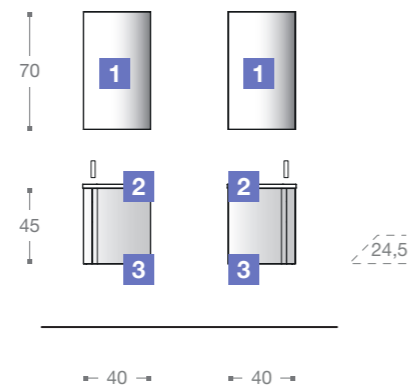

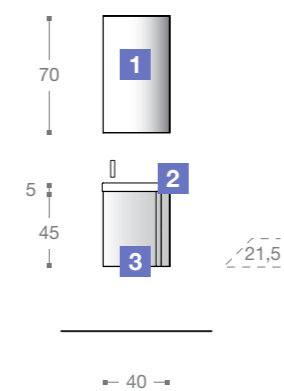

- 1** EDEN

---

- 2** CERAMICA - TK119  
*Ceramique / Ceramic / Keramik / Cerámica /  
Керамика*

---

- 3** 939 RIGATO IMPERIALE



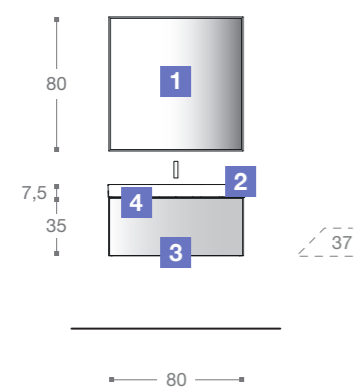

- 1 GENESIS**

---

- 2 CERAMICA - TK124**  
*Ceramique / Ceramic / Keramik / Cerámica /  
Керамика*

---

- 3 416 CRETA**  
*Opaco / Mat / Matt / Matt / Mate / Матовый*

---

- 4 G56 - BIANCO OPACO**  
*Blanc Mat / White Matt / Weiß Matt / Blanco  
Mate / Белый Матовый*





**IT.** Lavamani L.80 H.35 P.37 cm laccato opaco 416 Creta, apertura con maniglia G56 finitura bianco e lavabo in Ceramica bianco lucido. Specchio Genesis con luce Led integrata. Sopra particolare del lavabo in Ceramica che presenta uno smusso a 45° sul lato frontale.

**FR.** Meuble Lave-mains L.80 H.35 P.37 cm laqué 416 Creta mat, ouverture avec poignée G56 finition blanc et plan en céramique blanc brillant. Miroir Genesis avec lumière led intégrée. En haut détail du plan en céramique avec découpe à 45 degrés, dans son bord avant.

**EN.** Compact unit W.80 H.35 D.37 cm in 416 Creta matt finish, opening with G56 handle in white finish and basin in glossy white Ceramic. Genesis mirror with integrated Led light. Above detail of the washbasin in Ceramic with a 45° bevel on the front side.

**DE.** Gästewaschbecken B.80 H.35 T.37 cm matt lackiert 416 Creta. Öffnung mit G56 Griff in weißer Ausführung und Waschtisch in glänzend weißer Keramik. Genesis Spiegel mit integrierter Led-Licht. Oben: Detail des Waschbeckens aus Keramik mit einer 45°-Abschrägung an der Vorderseite.

**ES.** Lavamanos A.80 H.35 P.37 cm lacado mate 416 Creta, apertura con tirador G56 acabado blanco y lavabo de cerámica blanco brillo. Espejo Genesis con luz Led integrada. Arriba detalle del lavabo de cerámica que tiene un chaflán de 45° en el lado frontal.

**RU.** Рукомойник шир.80 выс.35 гл.37 см в матовой лаке 416 Creta с ручкой G56 в белой отделке и белой глянцевой керамической раковинной. Зеркало Genesis со встроенной светодиодной подсветкой. Деталь выше: керамический умывальник со скосом на передней стороне под углом 45°.

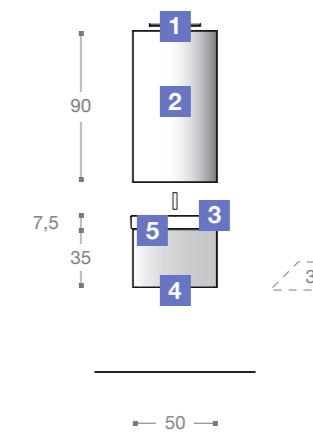

- 1 KUMA**

---

- 2 SPECCHIO FILO LUCIDO**  
Miroir simple / Simple mirror / Spiegel / Espejo  
canto pulido / Зеркало с полированными краями

---

- 3 CERAMICA - TK121**  
Ceramique / Ceramic / Keramik / Cerámica /  
Керамика

---

- 4 934 NOCE BROWN**

---

- 5 G56 - BIANCO OPACO**  
Blanc Mat / White Matt / Weiß Matt / Blanco  
Mate / Белый Матовый

LAVAMANI

Lave-mains / Compact unit / Gästewaschbecken / Lavamanos / Рукомойники

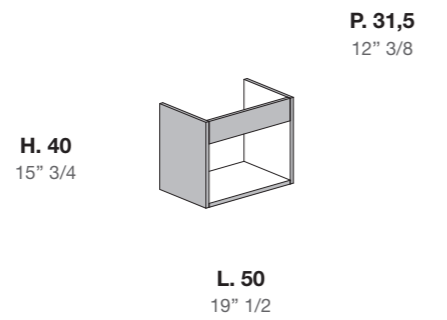
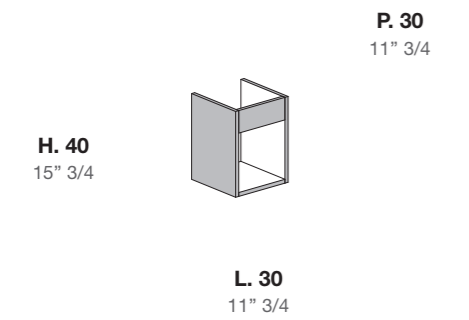
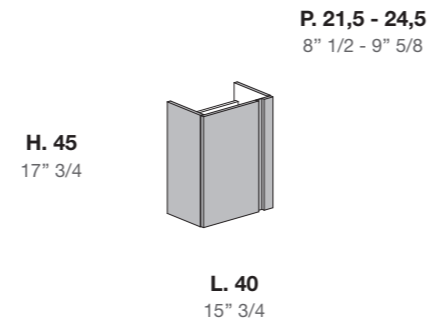
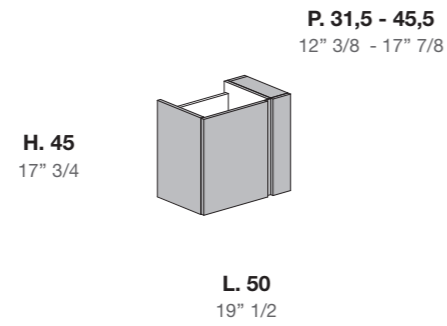
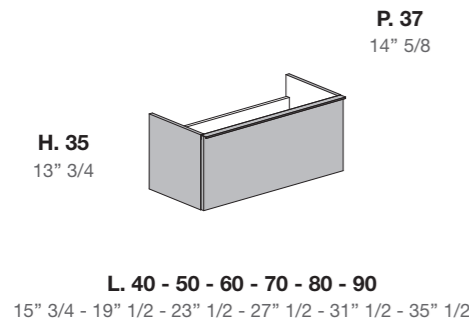

COLORI LACCATI OPACHI E LUCIDI

Couleurs mates et brillantes / Matt and glossy colours / Matt und glänzende lackierte Farben / Colores mates y brillos / Матов. и глянец. цвета

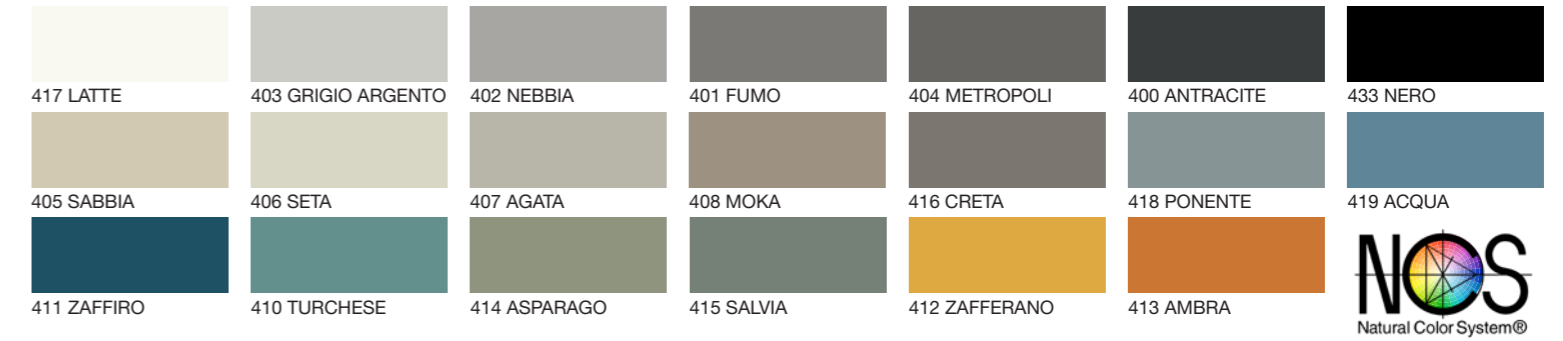

ESSENZE

Finition bois / Wood finishes / Holzoptik / Acabados madera / Отделки под дерево





